

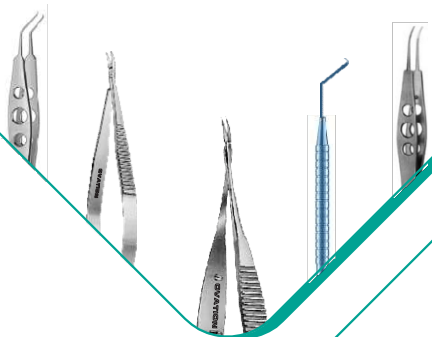

*Pioneer in Ophthalmic Products*

## OPHTHALMIC INSTRUMENTS SETS

CATARACT SET



LACRIMAL/DCR  
SET

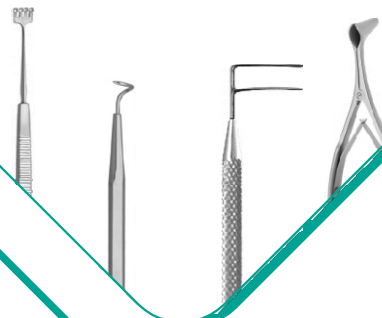

RETINAL SET



2025



OVATION is a leading company engaged in Manufacturing, Export & Imports of Ophthalmic Surgical Products. Ovation started his business in Year 1996 With A Vision to produce Internationally accepted Quality Ophthalmic Surgical Products with ability to meet ever changing demands of Ophthalmologists due to advancement in Surgical Techniques.

Ovation International is ISO :13485 Certified Company. Working according to European Medical Device Standards 93/42/EEC, Our Product Range of Disposable Ophthalmic Cannula's, Knives, Vitreoretinal, Cataract, Corneal & other Instruments are CE Certified from last 10 years. Conscious efforts are constantly made at Ovation to develop a long-term relationship with our costumers by providing quality products at relatively competitive prices in a framed time limit

Ovation is professionally managed company large enough to meet small and large requirements. In fact, the customized, individual and varied requirements are a source of pleasure for our dedicated workers.

due to continuous development and improvement the given specifications the product design and construction are subject to change without any notice.

All photographs, illustrations and texts of this catalogue should not be reproduced in any form or by any electronic or mechanical means, all are protected by copyright. reproduction in any form is prohibited.



# CERTIFICATE

Quality Austria Certification GmbH awards this **qualityaustria** certificate to the following organisation:

This **qualityaustria** certificate confirms the application and further development of an effective

**Ovation International**  
Office: B-24, (B-1), Prabhu Marg, Tilak Nagar,  
Jaipur-302004, Rajasthan, India.  
Works: H-167, Malviya Nagar, Malviya RIICO Area,  
Jaipur-302017, Rajasthan, India.

**QUALITY MANAGEMENT SYSTEM**  
complying with the requirements of standard  
**ISO 13485:2016**  
Medical devices - Quality management systems -  
Requirements for regulatory purposes

Quality Austria Certification GmbH is accredited according to the Austrian Accreditation Act by the BMWF/W (Federal Ministry of Science, Research and Economy).

Quality Austria is accredited as an organisation for environmental verification by the BMLFUW (Federal Ministry of Agriculture, Forestry, Environment and Water Management).

Quality Austria is authorized by the VDA (Association of the Automotive Industry).

For accreditation registration details please refer to the applicable decisions or recognition documents.

Quality Austria is the Austrian member of IQNET (International Certification Network).

Dok. Nr. FQ\_24\_008

486c2601-1931-48ee-b854-1666ecb37d7

The current validity of the certificate is documented exclusively on the Internet under <http://www.qualityaustria.com/en/cert>

MANUFACTURER AND SUPPLY OF SURGICAL INSTRUMENTS, SURGICAL KNIVES, CANNULAS, MARKERS, PROCEDURE PACKS (KIT) DIAGNOSTIC AND SURGICAL LENSES, OPHTHALMIC DEVICES FOR TISSUE MANIPULATION & FLUID MANAGEMENT.

The validity of the **qualityaustria** certificate will be maintained by annual surveillance audits and one renewal audit after three years.

Registration No.: M7-00466/0  
Date of initial issue: 21 January 2025  
Valid until: 20 January 2028

Vienna, 21 January 2025

Quality Austria Certification GmbH,  
AT-1010 Vienna, Zelinkagasse 10/3

Mag. Christoph Mondl  
CEO

Mag. Dr. Werner Paar  
CEO

Ing. Christoph Baumgartner, MSc, MBA  
Authorised representative,  
management Customer Service Center



Microsurgery Lacrimal Set (DCR)	1-2
Microsurgery Glucoma Set	3-4
Microsurgery Phaco Set (Compact)	5-5
Extracapsular Cataract Extraction Set (EC CE)	6-7
Microsurgery ECCE-Phaco Emulsification Set	8-9
Small Incision Cataract Surgery (SICS) SET	10-10
Microsurgery Evisceration Set	11-11
Microsurgery Entropion Set	11-11
Intracapsular Cataract Extraction Set (IC CE)	12-14
Microsurgery Corneal Transplant Set	15-16
Microsurgery Lasik Set	16-16
Microsurgery Radial Keratotomy Set	17-17

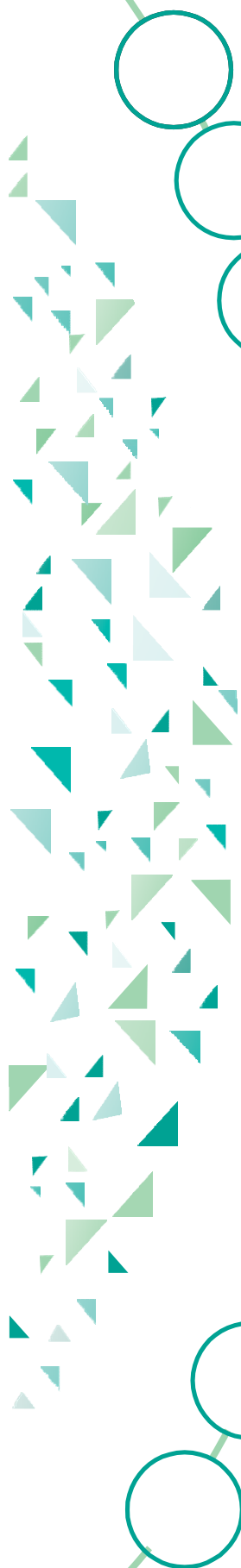

Microsurgery Lid Set	18-19
Microsurgery Enucleation Set	19-19
Microsurgery Chalazion Set	20-20
Microsurgery Muscle Set	21-22
Microsurgery Retinal Set	22-23
Foreign Body Removal Set	24-24
Microsurgery Pterygium Set	24-24
Microsurgery Cataract Set (Comp act)	25-25
Microsurgery Strabismus Set	26-26
DLEK / DSAEK / D ALK Set	27-28
Coaxial Microphaco Set	28-29
MICROSURGERY Keratoplasty Set	30-31

## Microsurgery Lacrimal Set (DCR)

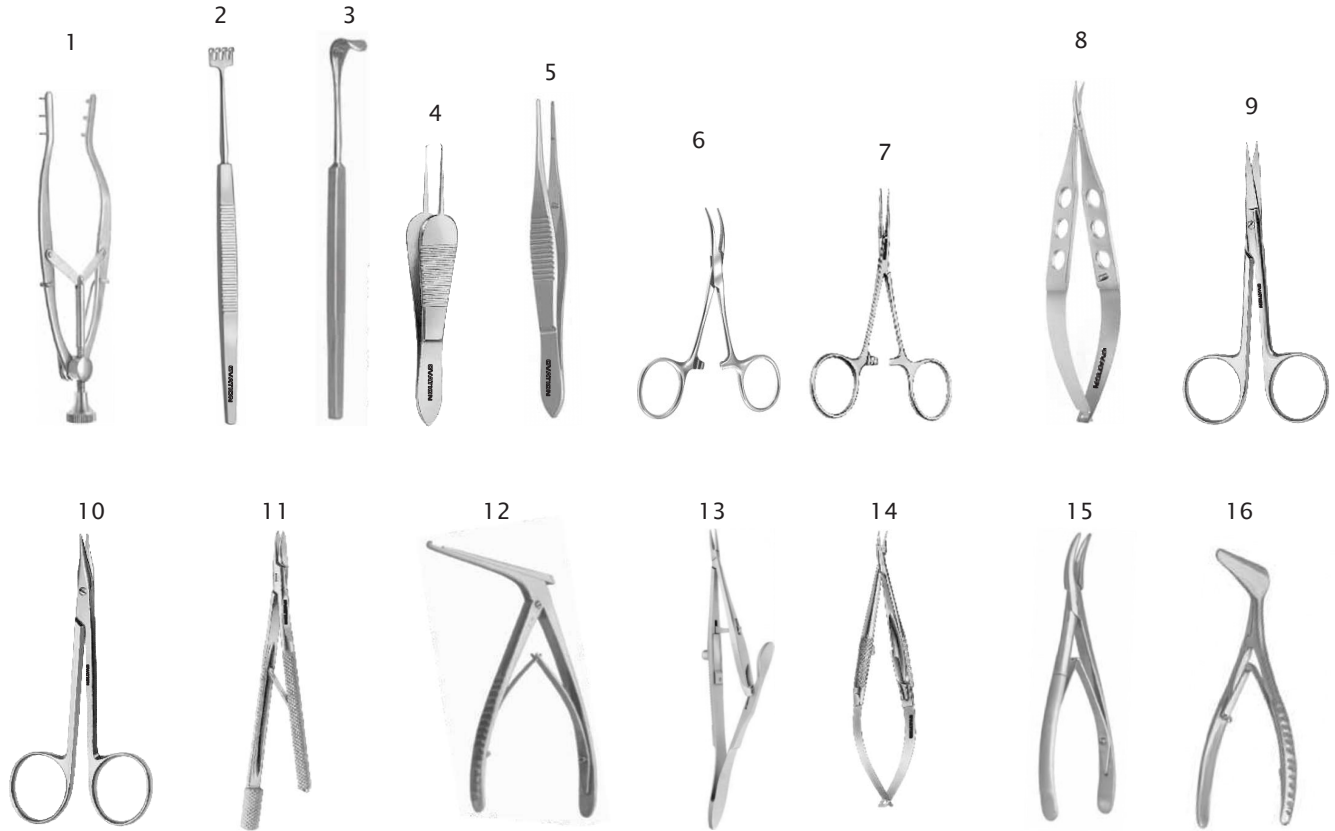

No.	Product Code	Product Name	Qty.
1.	OI-3102	Stevenson Lacrimal Sac Retractor, 3 x 3 Blunt Prongsk	1
2.	OI-3106	Knapp Lacrimal Sac Retractor, Blunt	1
3.	OI-3108	Desmarres Lid Retractor, Size 0	1
4.	OI-917	St. Martin Suturing Forceps, 1 x 2 Teeth	1
5.	OI-979	Wills Hospital Utility Forceps	1
6.	OI-2337	Hartman Mosquito Forceps, Curved	2
7.	OI-2308	Hartman Mosquito Forceps, Straight	2
8.	OI-815	Westcott Stitch Scissors	1
9.	OI-818	Eye Scissors, Straight, 4 1/2" Length	1
10.	OI-822	Stevens Tenotomy Scissors, Curved	1
11.	OI-2313	Kalt Needle Holder, Straight	1
12.	OI-2301	Barraquer N.Holder Micro Jaws, w/o Lock	1
13.	OI-2306	Troutman Razor Blade Holder 5.5mm handle, Straight	1
14.	OI-3602	Kerrison Bone Nibbling Ronguer, Size 0	1
15.	OI-3604	Beyer Ronguer, Single Action	1
16.	OI-3565	Nasal Speculum, Infant	1

## Microsurgery Lacrimal Set (DCR)

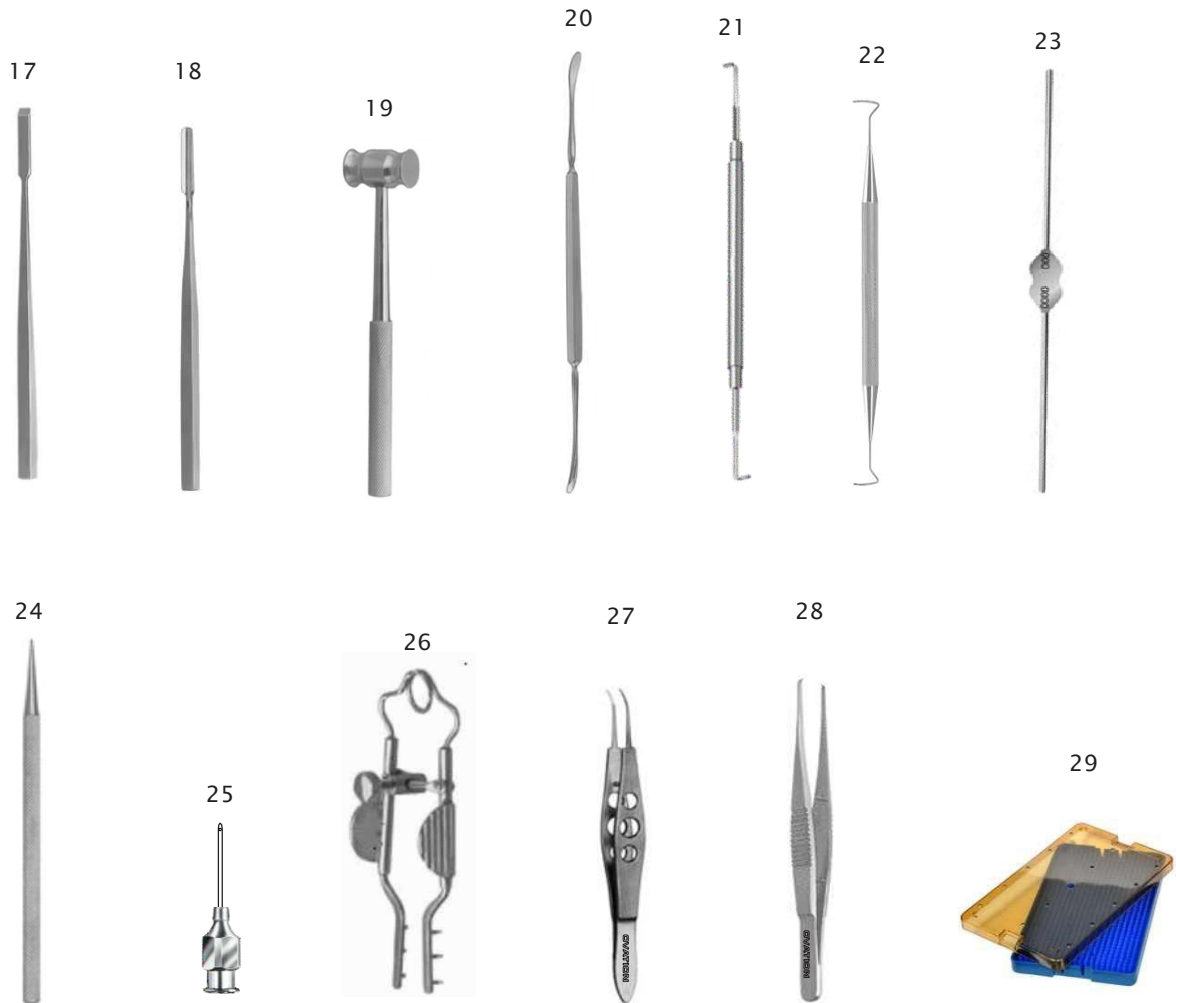

No.	Product Code	Product Name	Qty.
17.	OI-3551	West Lacrimal Chisel, Straight	1
18.	OI-3553	West Bone Gauge	1
19.	OI-3554	Mallet for DCR	1
20.	OI-3560	Freer Periosteal Elevator	1
21.	OI-3561	Traquair Periosteal Elevator	1
22.	OI-3562	Pigtail Probe with Suture Holes	1
23.	OI-3555	Bowman Lacrimal Probe, Malleable Stainless Steel	1
24.	OI-3557	Lacrimal Dialator Size 2 Medium Taper	1
25.	OC-197	West Lacrimal Cannula, Curved	1
26.	OI-3101	Mueller's Lacrimal Sac Retractor	1
27.	OI-901	JAFFE TYING FORCEPS	1
28.	OI-966	Fixation Forceps	1
29.	OI-5010	Polycarbonate Sterilisation tray large	1

## Microsurgery Glaucoma Set

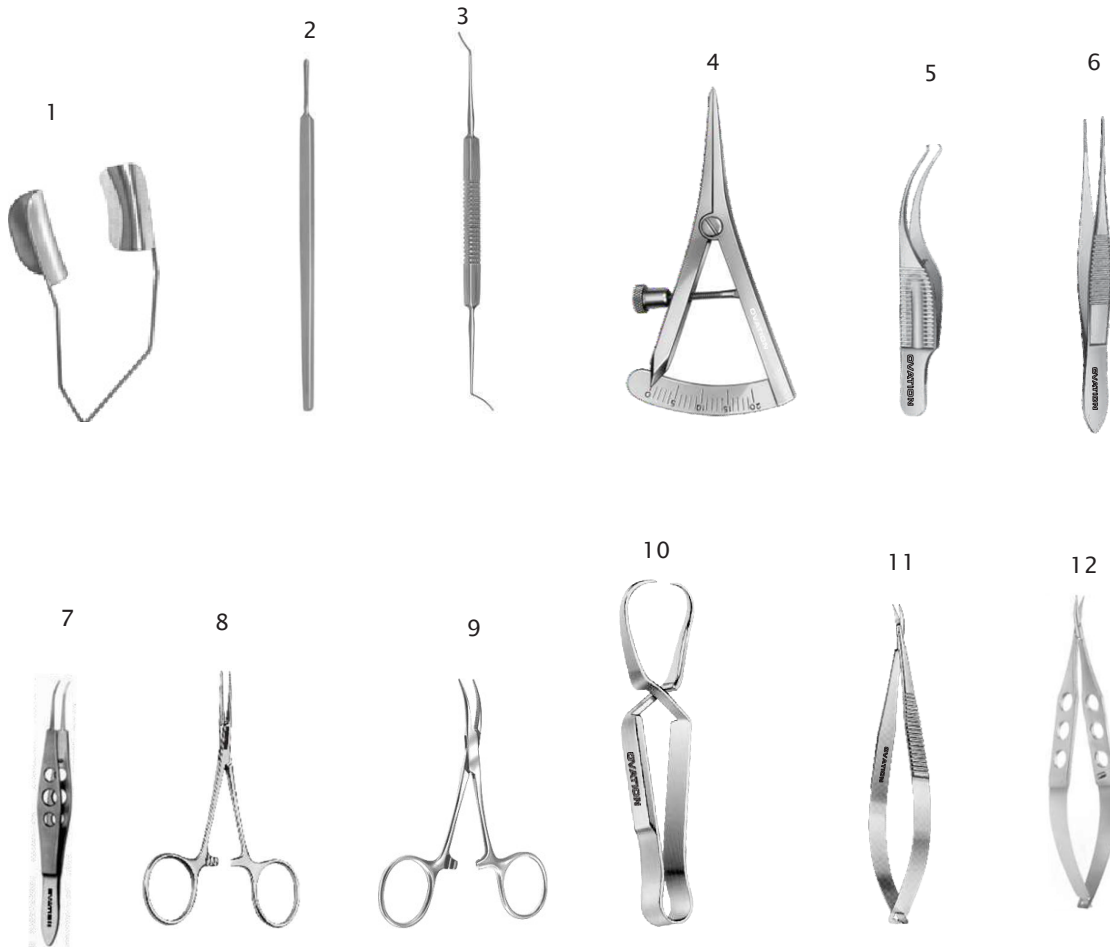

No.	Product Code	Product Name	Qty.
1.	OI-2406	Barraquer Wire Speculum, Large	1
2.	OI-3301	Tooke Corneal Knife	1
3.	OI-3202	Castroviejo Synechias Spatula, Double Ended	1
4.	OI-3351	Castroviejo Caliper, Straight	1
5.	OI-910	Colibri Forceps 1 x 2 Teeth, 0.12mm	1
6.	OI-922	Eye Dressing Forceps, Straight	1
7.	OI-901	Jaffe Tying Forceps, Curved	1
8.	OI-2308	Hartman Mosquito Forceps, Straight	2
9.	OI-2337	Hartman Mosquito Forceps, Curved	2
10.	OI-2310	Schadel Towel Forceps 90mm Length	1
11.	OI-801	Universal Corneal Scissors	1
12.	OI-815	Westcott Stitch Scissors	1

## Microsurgery Glucoma Set

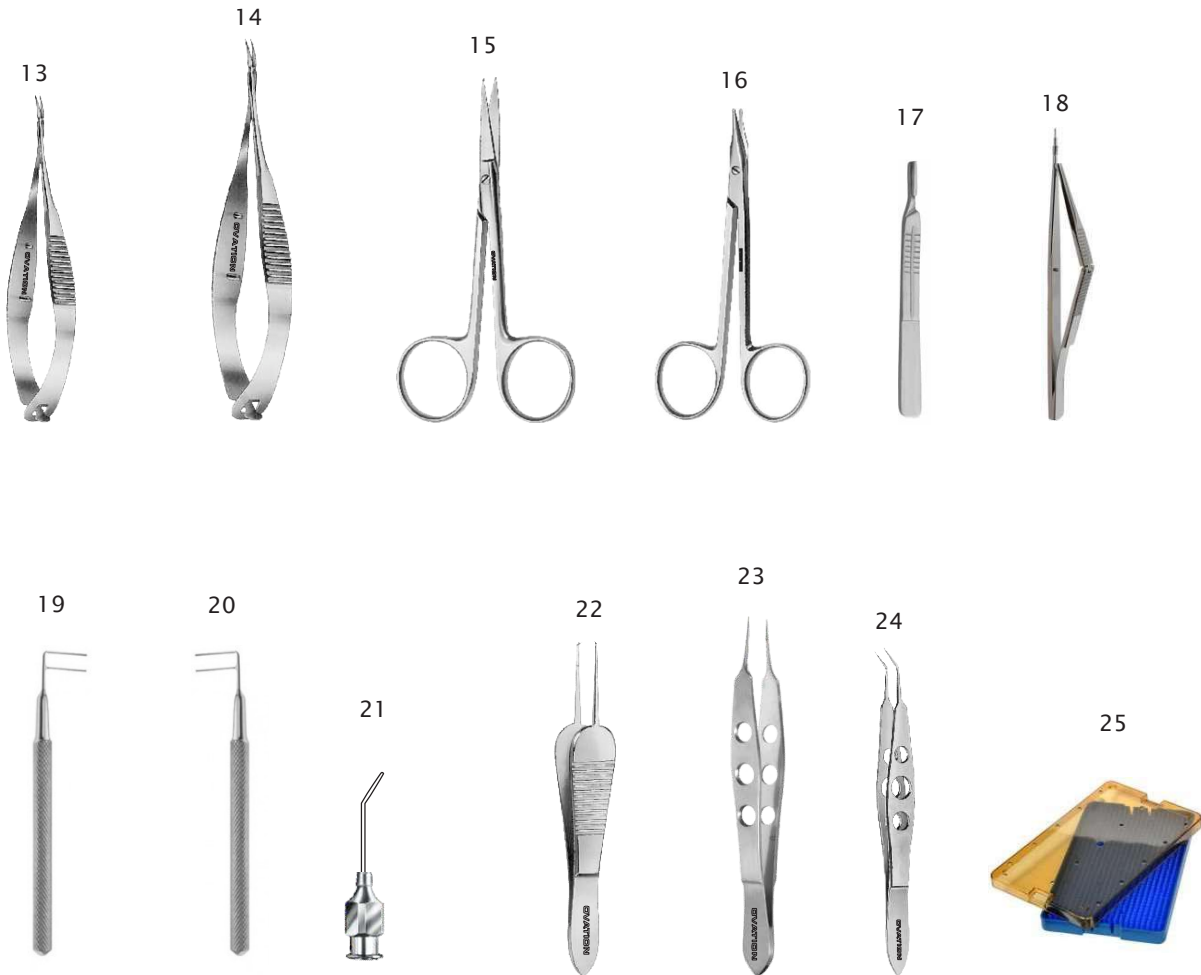

No.	Product Code	Product Name	Qty.
13.	OI-806	Vannas Scissors, Curved	1
14.	OI-808	Vannas Capsulotomy Scissors Forward 11mm Blade	1
15.	OI-818	Eye Scissors, Curved 4 1/2" Length	1
16.	OI-822	Stevens Tenotomy Scissors, Curved	1
17.	OI-2318	Blade Handle Flat # 3	1
18.	OI-3601	Kelly Descemet's Membrane Punch, 1.0mm dia Tip	1
19.	OI-3563	Harms Trabeculotomy Probe, Left	1
20.	OI-3564	Harms Trabeculotomy Probe, Right	1
21.	OC-113	Rycroft Air Injection Cannula, 27G	1
22.	OI-917	St. Martin Forceps	1
23.	OI-916	Bonn Tooth Forceps, 1 x 2 Teeth	1
24.	OI-903	Mc Pherson Tying Forceps	1
25.	OI-5010	Polycarbonate Sterilisation tray large	1

## Microsurgery Phaco Cataract Set (Compact)

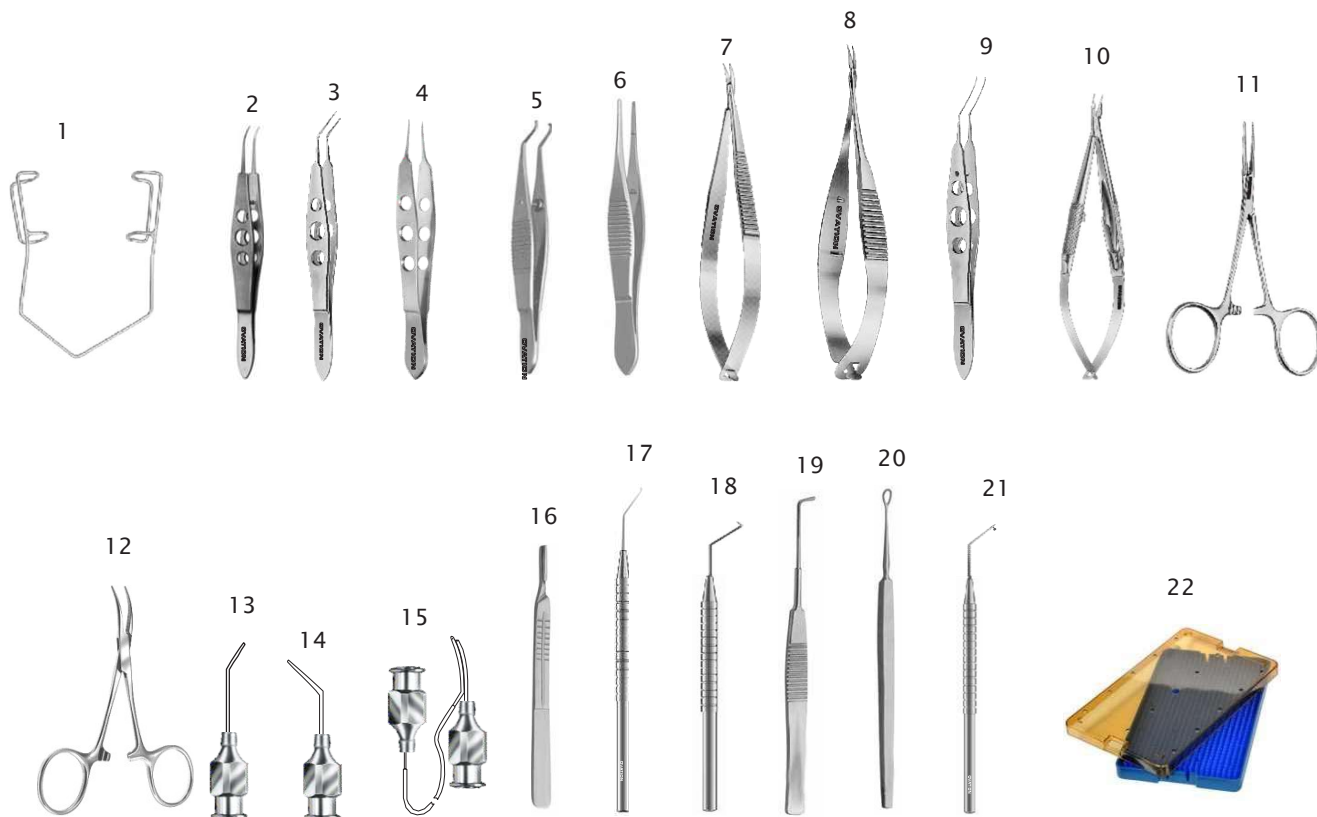

No.	Product Code	Product Name	Qty.
1.	OI-2406	Barraquer Wire Speculum, Large	1
2.	OI-901	Jaffe Tying Forceps, Curved	1
3.	OI-904	Mc Pherson Forceps, Angled	1
4.	OI-963	Bonn forceps straight	1
5.	OI-964	Superior Rectus Forceps	1
6.	OI-979	Wills Hospital Utility Forceps	1
7.	OI-801	Universal Corneal Scissors	1
8.	OI-808	Vannas Capsulotomy Scissors, Angled	1
9.	OI-905	Utrata Capsulorhexis Forceps, Flat Handle	1
10.	OI-2301	Barraquer Needle Holder, Micro Jaws w/o Lock	1
11.	OI-2308	Hartman Mosquito Forceps, Straight	1
12.	OI-2337	Hartman Mosquito Forceps, Curved	1
13.	OC113	Anterior Chamber Cannula 25G	1
14.	OC131	Hydrodissection Cannula	1
15.	OC122	Simcoe I/A Cannula, Direct	1
16.	OI-2318	Blade Handle Flat	1
17.	OI-2616	Nucleus Chopper, Sharp	1
18.	OC152	Sinsky Lens Manipulating Hook	1
19.	OI-3152	Lewis Lens Loop, (Wire Vectus)	1
20.	OI-3151	Ovation Lens Expressor	1
21.	OI-3201	IRIS SPETULA (BARRAQUER)	1
22.	OI-5010	Polycarbonate Sterilisation Tray large ( 6.0 x 10 x 0.75) Inch	1

## Extracapsular Cataract Extraction Set (EC CE)

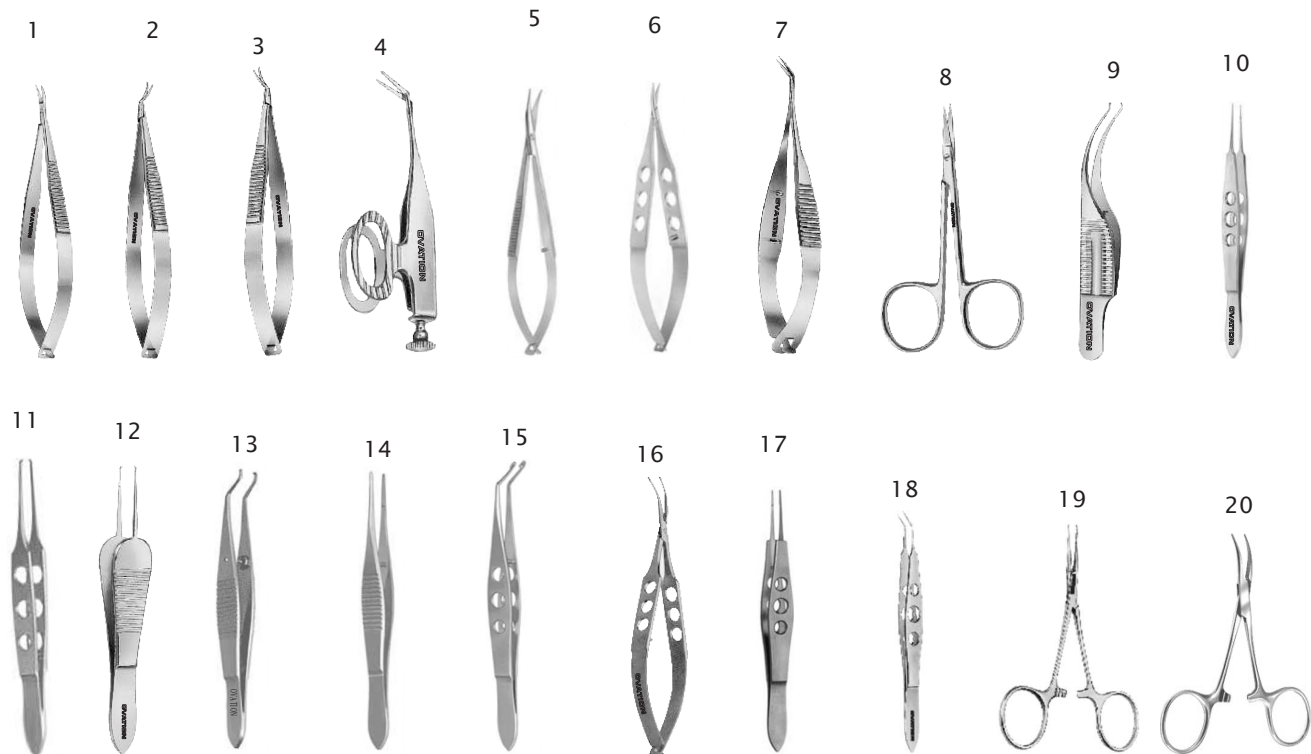

No.	Product Code	Product Name	Qty.
1.	OI-801	Universal Corneal Scissor Fine Curved blades	1
2.	OI-803	Castroviejo Corneoscleral Scissors, Small Blade, Left	1
3.	OI-804	Castroviejo Corneoscleral Scissors, Small Blade,Right	1
4.	OI-812	Barraquer Iris Scissors Blunt	1
5.	OI-814	Westcott Tentomy scissors Strd Blades Curved, 12cm Blunt Tip	1
6.	OI-815	Westcott Stitch Scissors	1
7.	OI-808	Vannas Capsulotomy Scissors, Ang. Forward, 11mm Blade	1
8.	OI-816	Iris Scissors,Straight	1
9.	OI-910	Colibri Forceps, 1x2 Teeth,0.12mm	1
10.	OI-916	Mc Pherson CornealForceps, 1 x 2 Teeth	1
11.	OI-965	Bishop-Harmon Tissue Forceps, Delicate 0.8mm	1
12.	OI-917	St. Martin Suturing Forceps, 1 x 2 Teeth	1
13.	OI-964	Dastoor Superior Rectus Forceps, 1x2 Teeth	1
14.	OI-979	Wills Hospital Utility Forceps	1
15.	OI-925	Arruga Capsule Forceps	1
16.	OI-933	Shepard IOL Forceps	1
17.	OI-902	Jaffe Tying Forceps,Straight	1
18.	OI-903	Mc Pherson Tying Forceps	1
19.	OI-2308	Hartman Mosquito Forceps, Straight	1
20.	OI-2336	Hartman Mosquito Forceps, Curved	1

## Extracapsular Cataract Extraction Set (EC CE)

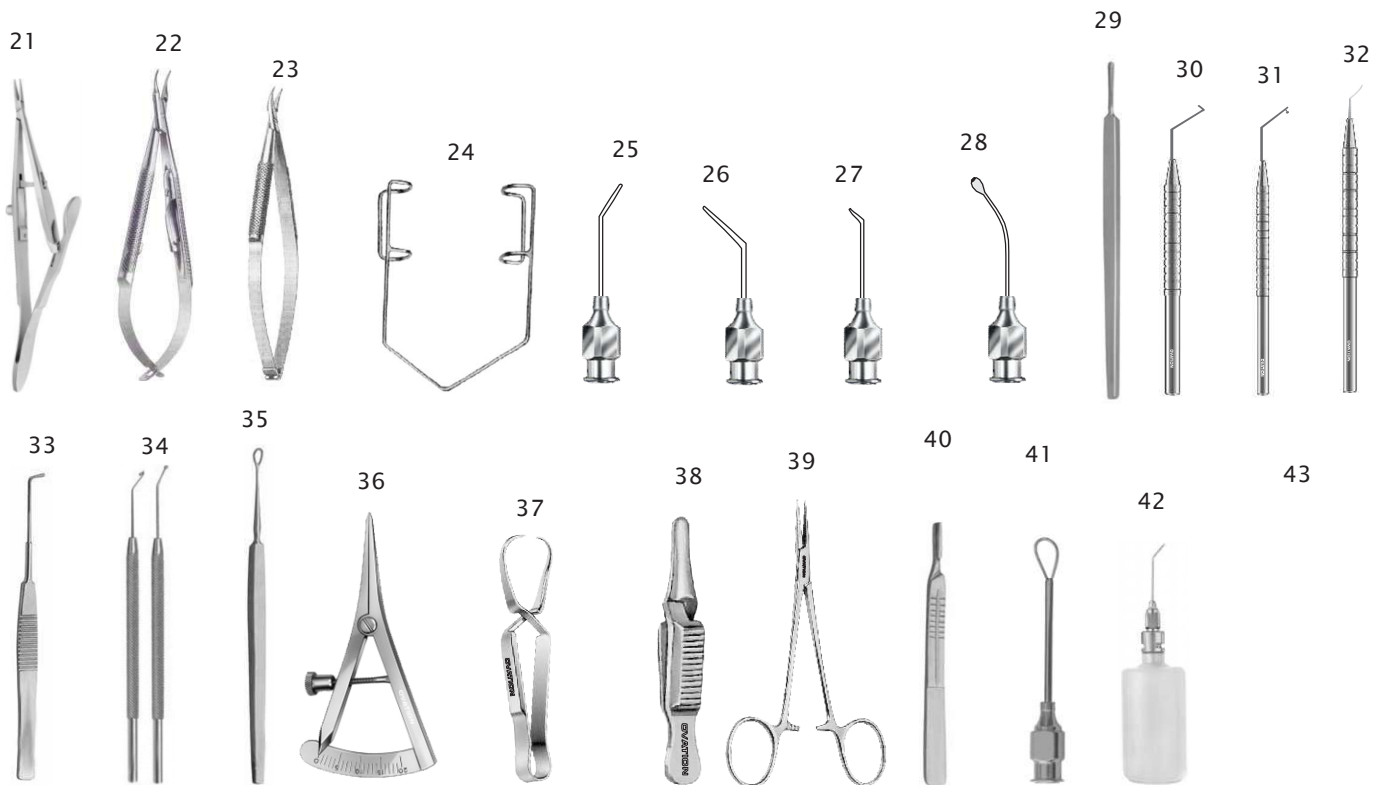

No.	Product Code	Product Name	Qty.
21.	OI-2313	Kalt Needle Holder, Straight	1
22.	OI-2319	Barraquer N Holder, Short Model, M.Jaws, Cur.w/o Lock	1
23.	OI-2324	Barraquer N Holder, Standard Jaws, Curved Jaws,w/o Lock	1
24.	OI-2401	Barraquer Wire Speculum, Large	1
25.	OC-113	Rycroft Air Injection Cannula, 16G	1
26.	OC-131	Pearce Hydrosdissection Cannula, 35° Ang. 25G	1
27.	OC-129	Kellan Hydrodelineation, Curved Bevel Tip, 25G	1
28.	OC-182	Jensen Capsule Polisher, Sand BlastOlive Tip, 23G	1
29.	OI-3301	Took Corneal Knife	1
30.	OC-152	Sinsky II Lens manipulation Hook, Angled	1
31.	OC-186	Iris Hook and Lens Manipulator Push Pull Model	1
32.	OI-3201	Barraquer Iris Spatula, 0.25mm, Angled	1
33.	OI-3151	OVATION LENS EXPRESSOR	1
34.	OI-3658	Nightingale Capsule Polisher, Posterior	1
35.	OI-3152	Lewis lens Loop, Small (WireVectus)	1
36.	OI-3351	Castroviejo Caliper, Straight	1
37.	OI-2310	Schadel Towel Forceps 90mm Length	1
38.	OI-2311	Serrefine Small, Straight	1
39.	OI-2306	Troutman Blade Breaker and Holder, Small	1
40.	OI-2318	Blade Handle Flat	1
41.	OC-159	Knolle -Pearce irrigation Vectis	1
42.	OI-3851	Silicone Bulb with Adapter	1
43.	OI-5003	Sterilization Box with Two Silicone Mats	1

## Microsurgery ECCE-Phaco Emulsification Set

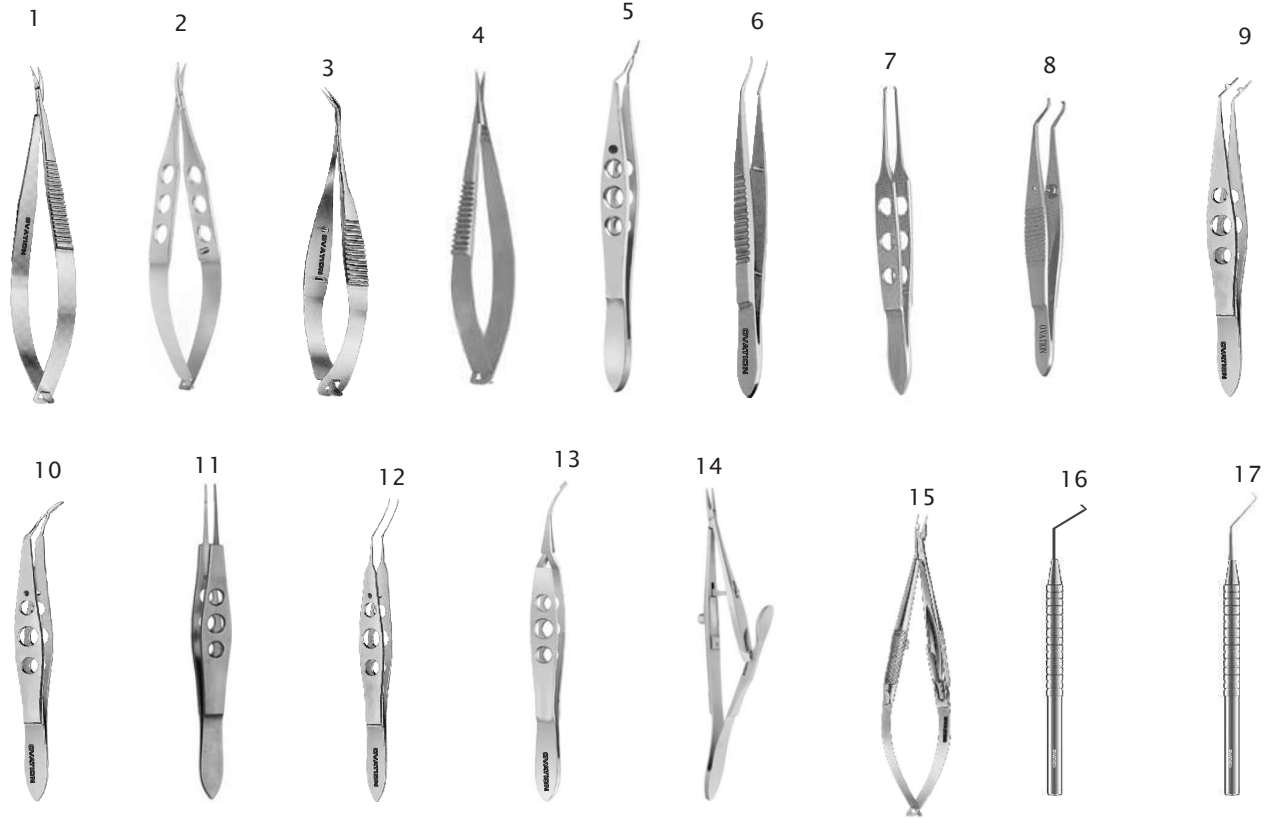

No.	Product Code	Product Name	Qty.
1.	OI-801	Universal Corneal Scissor Fine Curved blades	1
2.	OI-814	Westcott Stitch Scissors Curved, Blunt Tips	1
3.	OI-808	Vannas Capsulotomy Scissors, Ang. Forward, 11mm Blade	1
4.	OI-818	Iris Scissors, Straight 4.5 Length	1
5.	OI-983	Akahoshi Prechoper Forceps Curved	1
6.	OI-913	Lim's Corneoscleral Forceps, 0.12mm, 1x2 Teeth	1
7.	OI-965	Bishop Harmon Tissue Forceps, Delicate 0.8mm	1
8.	OI-964	Dastoor Superior Rectus Forceps, 1x2 Teeth	1
9.	OI-936	Lens Folding Forceps	1
10.	OI-937	Lens Inserting Forceps	1
11.	OI-902	Jaffe Tying Forceps, Straight	1
12.	OI-905	Utrata Capsulorhexis Forceps, Flat Handle	1
13.	OI-981	Dodick Nucleus Cracker	1
14.	OI-2313	Kalt Needle Holder, Straight	1
15.	OI-2301	Barraquer N.Holder, Micro Jaws, Curved W/o Lock for 10' Suture	1
16.	OC-152	Sinsky II Lens manipulation Hook, Angled	1
17.	OI-3852	Akahoshi Nucleus Ring Sustainer	1

## Microsurgery ECCE-Phaco Emulsification Set

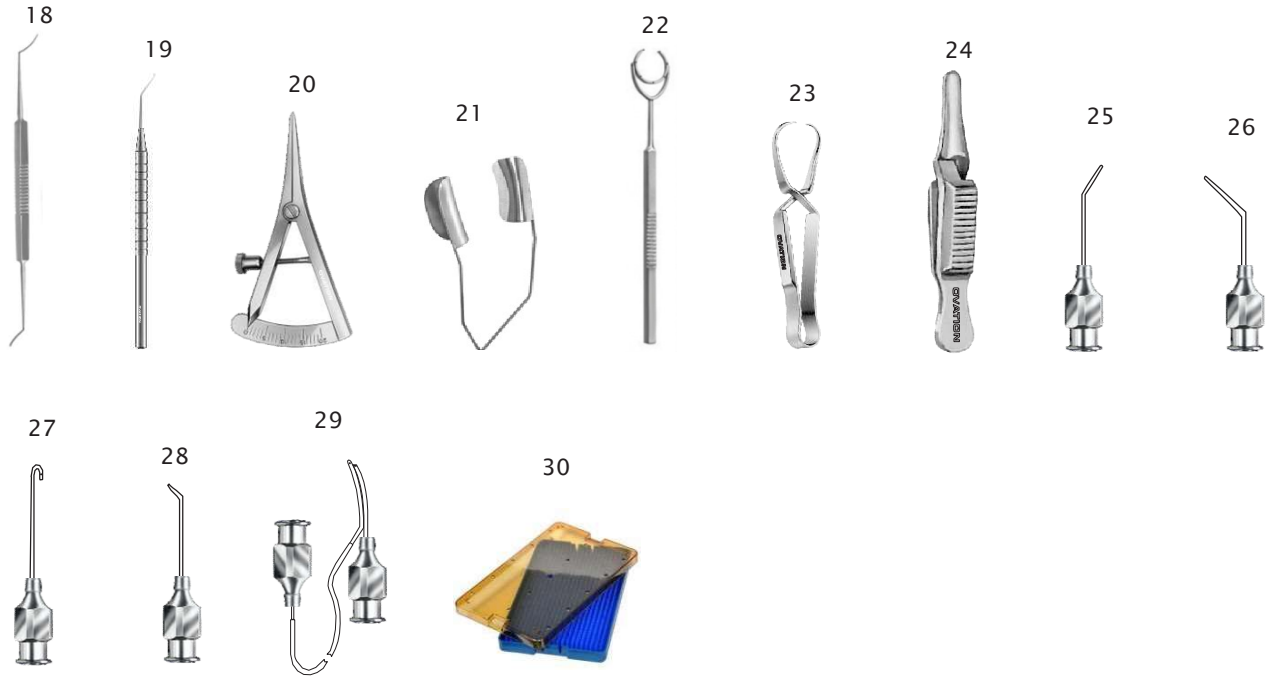

No.	Product Code	Product Name	Qty.
18.	OI-3204	Castroviejo Cyclodialysis Spatula, 0.50mm Wide	1
19.	OI-2601	NAGAHARA nucleus spatula Flat Inferior Edge	1
20.	OI-3351	Castroviejo Caliper, Straight	1
21.	OI-2412	Barraquer Wire Speculum, Large	1
22.	OI-3503	Shepard Fixation Ring	1
23.	OI-2310	Schadel Towel Forceps 90mm Length	1
24.	OI-2311	Serrefine Small, Straight	2
25.	OC-113	Rycroft Air Injection Cannula, 23G	2
26.	OC-131	Pearce Hydrosdissection Cannula, 35° Ang. 25G	2
27.	OC-175	J SHAPED CANNULA (Inside Port)	1
28.	OC-129	Kellan Hydrodelineation, Curved Bevel Tip,	1
29.	OC-122	Simcoe I/ACannula, 23G,Direct	1
30.	OI-5009	large tray	1

## Small Incision Cataract Surgery (SICS) SET

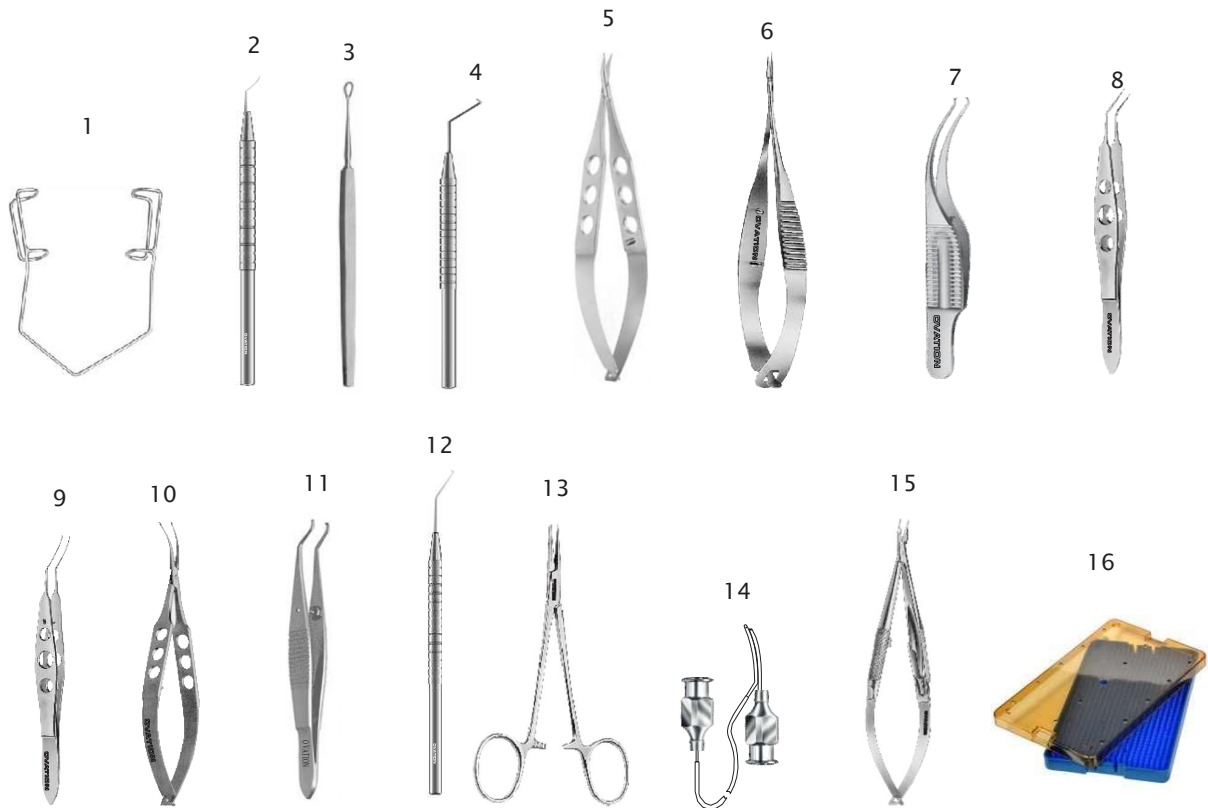

No.	Product Code	Product Name	Qty.
1.	OI-2406	Barraquer Eye Speculum	1
2.	OI-3201	IRIS Spetula (Barraquer)	1
3.	OI-3152	Lewis Lens Loop, (Wire Vectus)	1
4.	OC152	Sinskey Lens Manipulating Hook	1
5.	OI-815	Westcott Stitch Scissors	1
6.	OI-805	Vannas Capsulotomy Scissors Tip Straight	1
7.	OI-910	Colibri Forceps 1 x 2 Teeth, 0.12 mm	1
8.	OI-904	Mc Pherson Forceps, Angled	1
9.	OI-905	Utrata Capsulorhexis Forceps,	1
10.	OI-933	Shepard IOL Forceps	1
11.	OI-964	Superior Rectus Forceps	1
12.	OI-2616	Phaco Chopper, Sharp Tip SS	1
13.	OI-2307	Halstead Mosquito Forceps Straight	1
14.	OC122	Simoce I/A Cannula 23G	1
15.	OI-2301	Barraquer Needle Holder, Micro Jaws w/o Lock	1
16.	OI-5009	Polycarbonate Sterilisation Tray large	1

## Microsurgery Evisceration Set

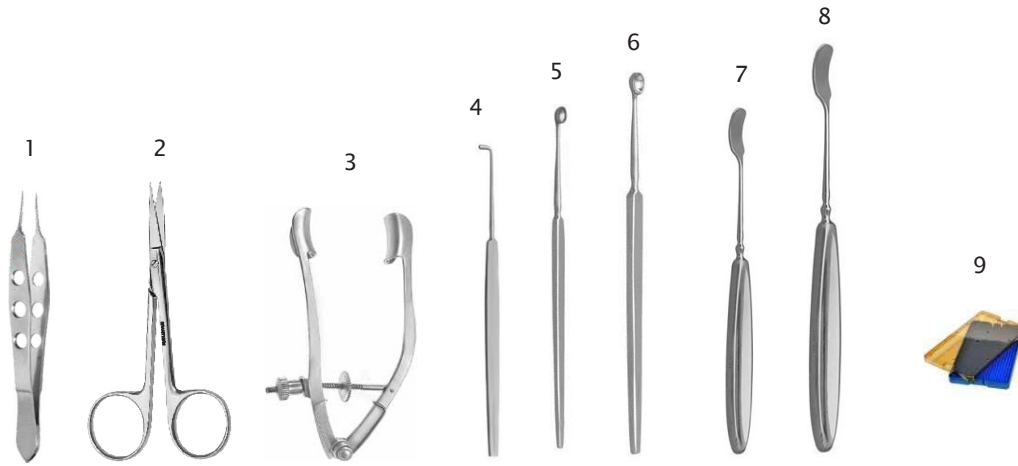

No.	Product Code	Product Name	Qty.
1.	OI-915	Bonn Forceps 1 x 2 Teeth	1
2.	OI-818	IRIS Scissor, Tip Ring Handle 4.5" Straight	1
3.	OI-2423	Lancaster Eye Speculum Solid Blade	1
4.	OI-3452	Graefe Muscle Hook # 1 8mm	1
5.	OI-3661	Bunge Evisceration Spoon Small	1
6.	OI-3662	Bunge Evisceration Spoon Large	1
7.	OI-3663	Evisceration Spoon Small	1
8.	OI-3664	Evisceration Spoon Large	1
9.	OI-5007	Polycarbonate Sterilisation Tray Small ( 2.5 x 6.0 x 0.75)"	1

## Microsurgery Entropion Set



No.	Product Code	Product Name	Qty.
1.	OI-915	Bonn Forceps 1 x 2 Teeth	1
2.	OI-818	IRIS Scissor Delicate Tip Ring Handle 4.5 Length Straight	1
3.	OI-3118	Jaeger Lid Plate	1
4.	OI-979	Wills Hospital Utility Forceps	1
5.	OI-2337	Hartmann Mosquito Forceps Curved	2
6.	OI-2303	Castroviejo Needle Holder Curved,	1
7.	OI-991	Snellen Entropium Forceps Left	1
8.	OI-992	Snellen Entropium Forceps Right	1
9.	OI-5006	Polycarbonate Sterilisation Tray Small ( 2.5 x 6.0 x 0.75) Inch	1

## Intracapsular Cataract Extraction Set (IC CE)

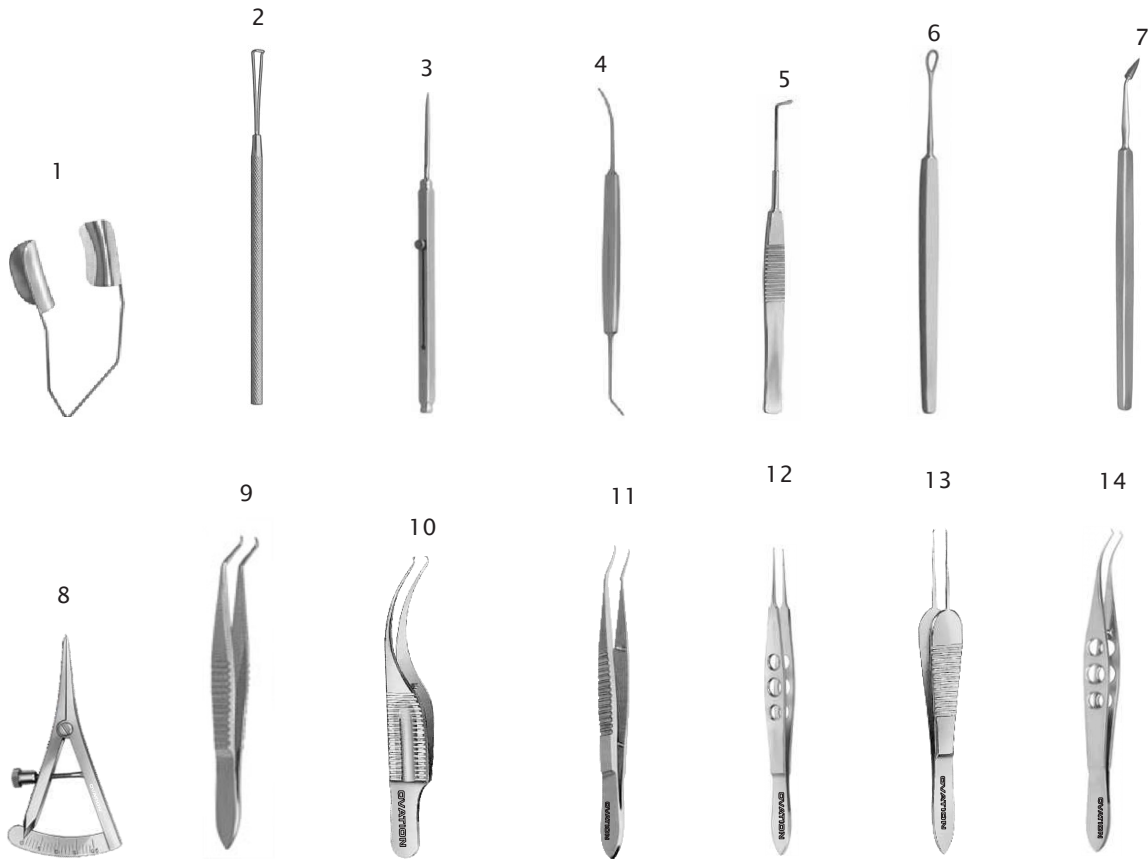

No.	Product Code	Product Name	Qty.
1.	OI-2412	Barraquer Wire Speculum, Large	1
2.	OI-3111	Dastoor Iris Retractor, Straight	1
3.	OI-3306	Barraquer Cataract Knife in Sliding Case	1
4.	OI-3205	Iris Spatula Double Ended	1
5.	OI-3151	Lens Expressor	1
6.	OI-3152	Lewis Lens Loop, Small	1
7.	OI-3667	Cautery Cone Type (Copper)	1
8.	OI-3351	Castroviejo Caliper, Straight	1
9.	OI-974	Hess Iris Forceps, 1 x 2 Teeth, Standard Model	1
10.	OI-910	Colibri Forceps, 1 x 2 Teeth, 0.12mm	1
11.	OI-913	Lim's Corneoscleral Forceps, ST. 0.4mm, 1 x 2 Teeth	1
12.	OI-916	Mc Pherson Corneal Forceps, St. 0.4mm, 1 x 2 Teeth	1
13.	OI-917	St. Martin Suturing Forceps, 1 x 2 Teeth	1
14.	OI-966	Fixation Forceps, 1 x 2 Teeth	1

## Intracapsular Cataract Extraction Set (IC CE)

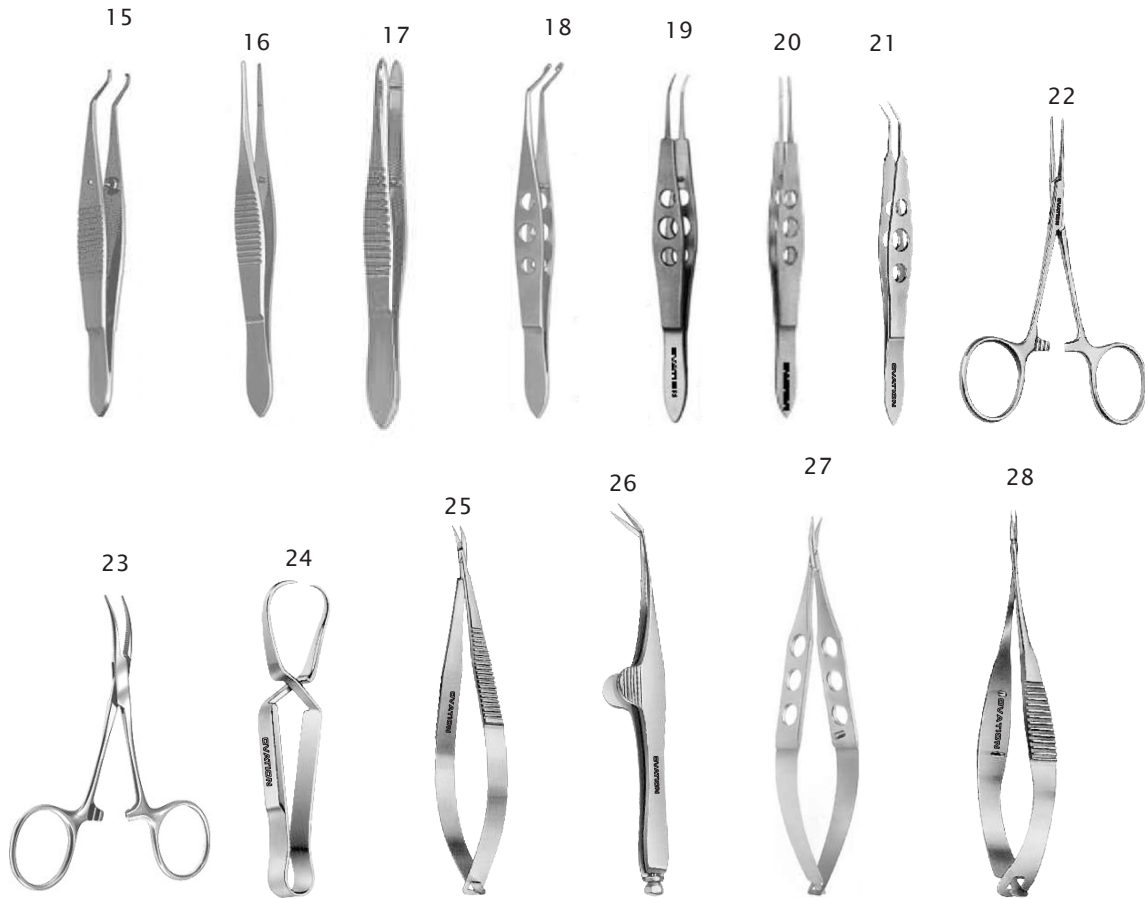

No.	Product Code	Product Name	Qty.
15.	OI-964	Dastoor Superior Rectus Forceps, 1 x 2 Teeth	1
16.	OI-979	Wills Hospital Utility Forceps	1
17.	OI-978	Beer Cilia Forceps	1
18.	OI-925	Arruga Capsule Forceps	1
19.	OI-901	Jaffe Tying Forceps, Curved	1
20.	OI-902	Mc Pherson Tying Forceps, Long Handle	1
21.	OI-903	Mc Pherson Forceps, 11mm Angled	1
22.	OI-2308	Hartman Mosquito Forceps, Straight	1
23.	OI-2337	Hartman Mosquito Forceps, Curved	1
24.	OI-2310	Baby Jones Towel Clamp	1
25.	OI-801	Castroviejo Corneal Scissors, Small Blades	1
26.	OI-813	De-Wecker's Iris Scissors, Sharp - Blunt	1
27.	OI-815	Westcott Stitch Scissors	1
28.	OI-805	Vannas Capsulotomy Scissors	1

## Intracapsular Cataract Extraction Set (IC CE)

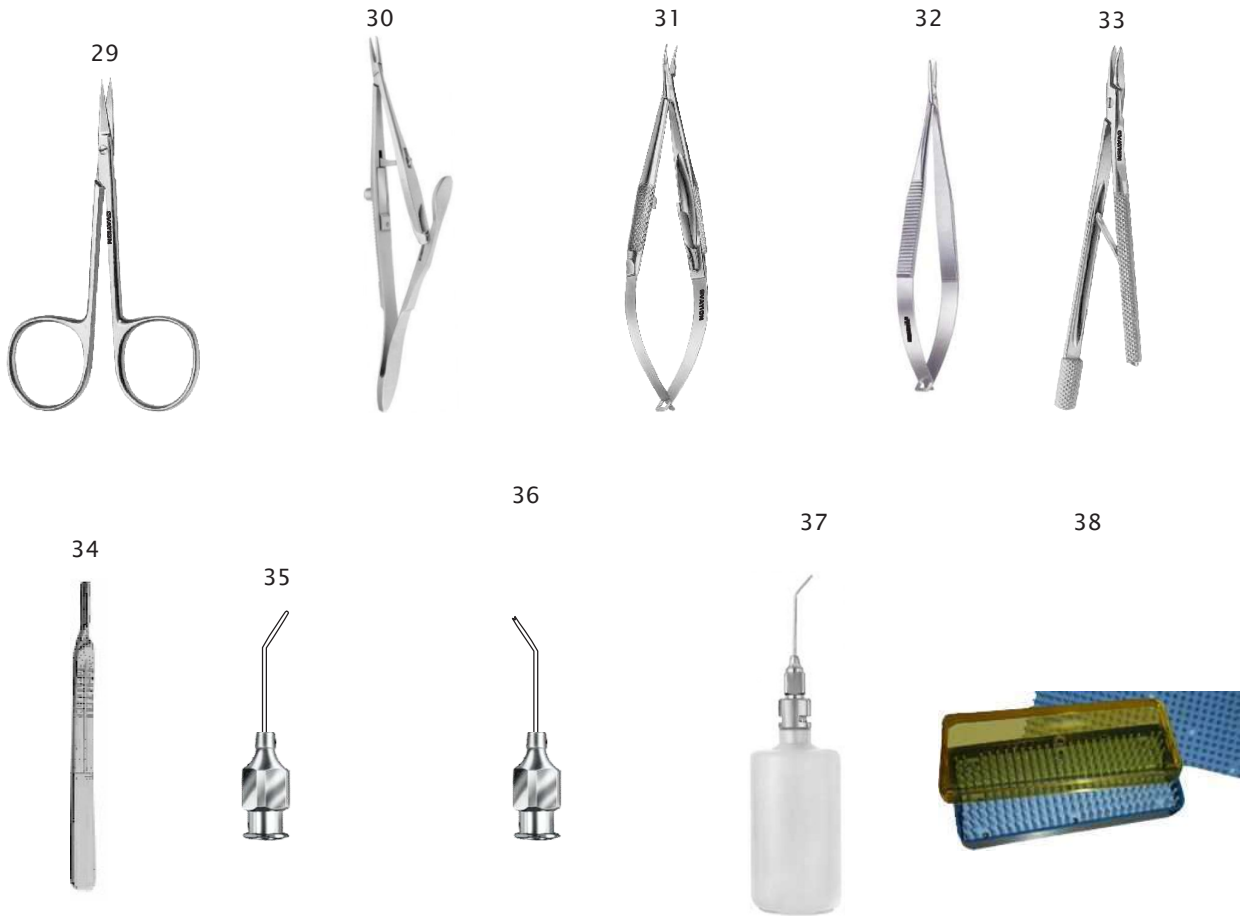

No.	Product Code	Product Name	Qty.
29.	OI-816	Iris Scissors, Straight	1
30.	OI-2313	Kalt Needle Holder, Straight	1
31.	OI-2301	Barraquer N. Holder, Short Model, M.Jaws, Cur. w/o lock	1
32.	OI-2302	Barraquer N. Holder, Standard Jaws, Curved Jaws, w/o lock	1
33.	OI-2306	Castroviejo Blade Breaker and Holder, Big	1
34.	OI-2318	Blade Handle Flat	1
35.	OC-113	Rycroft Air Injection Cannula, 23G	1
36.	OC119	Bishop Harmon Anterior Chamber Cannula, 19G	1
37.	OI-3851	Silicone Bulb With Adaptor	1
38.	OI-5002	Sterilization Box with Two Silicone Mats	1

## Microsurgery Corneal Transplant Set

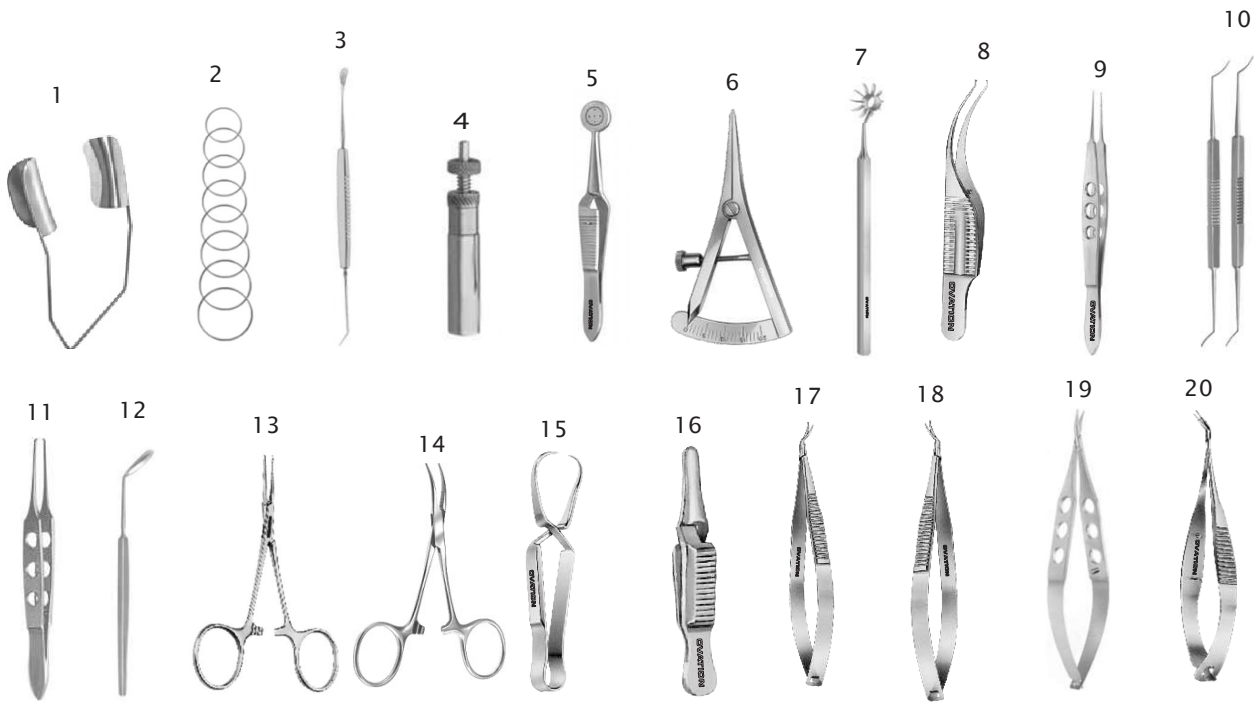

No.	Product Code	Product Name	Qty.
1.	OI-2412	Barraquer Wire Speculum, Large	1
2.	OI-3504	Flieringa Scleral Fixation Ring (Set of 8 Sizes)	1
3.	OI-3207	Paton Spatula and Spoon	1
4.	OI-3403	Castroviejo Corneal Trephine, Size 7.5mm Dia	1
5.	OI-1000	Corneal Graft Holding Forceps	1
6.	OI-3351	Castroviejo Caliper Straight	1
7.	OI-2637	Osher - Neumann Radial Marker, 8 Blades	1
8.	OI-910	Colibri Forceps, 1 x 2 Teeth, 0.12mm	1
9.	OI-963	BONN FORCEPS STRAIGHT 1 x 2 TEETH SET	1
10.	OI-3204	Castroviejo Cyclodialysis Spatula	1
11.	OI-965	Bishop - Harmon Tissue Forceps, Delicate, 0.8mm	1
12.	OI-3206	Dastoor Keratoplasty Spatula	1
13.	OI-2308	Hartman Mosquito Forceps, Straight	1
14.	OI- 2337	Hartman Mosquito Forceps, Curved	1
15.	OI-2310	Schaedel Towel Forceps 90mm Length	1
16.	OI-2311	Serrefine Small, Straight	1
17.	OI-804	Castroviejo Corneoscleral Scissors, Small Blade, Left	1
18.	OI-803	Castroviejo Corneoscleral Scissors, Small Blade, Right	1
19.	OI-815	Westcott Stitch Scissors	1
20.	OI-808	Vannas Capsulotomy Scissors, Ang. Forward, 11mm Blade	1

## Microsurgery Corneal Transplant Set

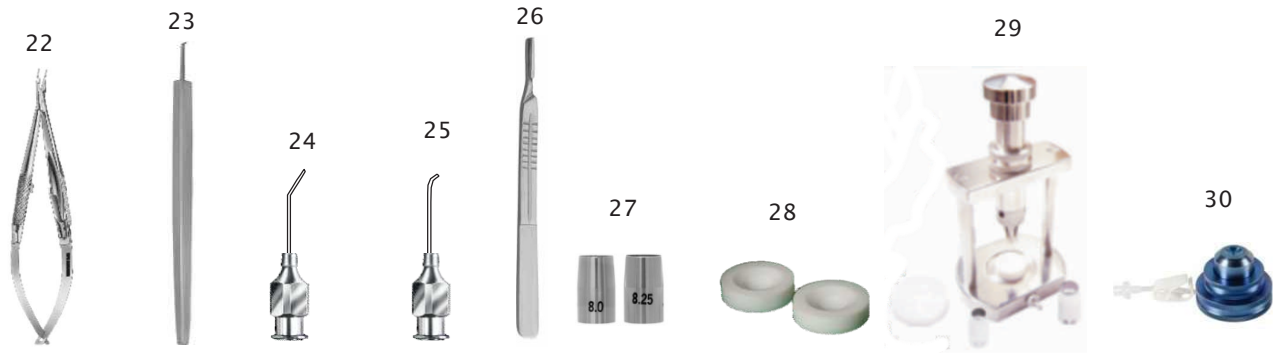

No.	Product Code	Product Name	Qty.
22.	OI-2301	Barraquer N. Holder, Short Model, M.Jaws, Cur. w/o lock	1
23.	OI-3308	Paufique Graft Knife	1
24.	OC113	Rycroft Air Injection Cannula, 27G	2
25.	OC114	Bracken Anterior Chamber Cannula, Curved, 19G	2
26.	OI-2318	Blade Handle Flat	1
27.	OI-3401	Disposable Corneal Traphines	8
28.	OI-3406	Lieberman Teflon Block	1
29.	OI-3405	ENDOTHELIAL PUNCH	1
30.	OI-3404	Artificial Anterior Chamber Maintainer Titanium	1

## Microsurgery Lasik Set

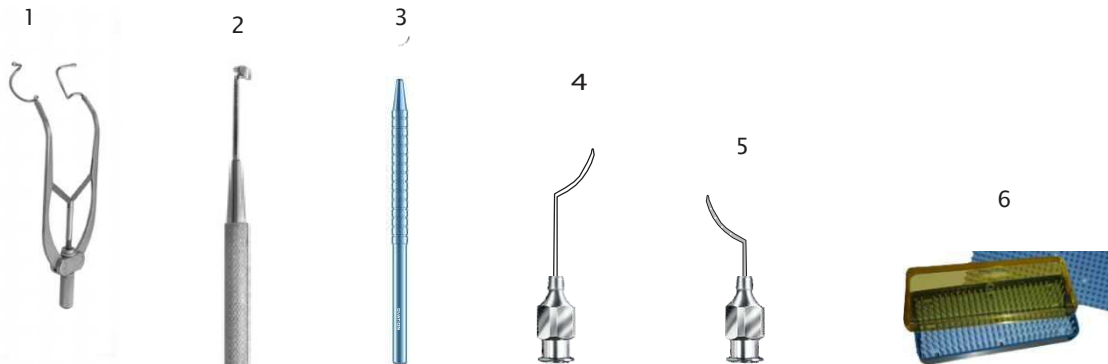

No.	Product Code	Product Name
1.	OI-2424	Castroviejo Lasik Speculum
2.	OI-3253	Lasik Depressor
3.	OC183	Lasik Spatula
4.	OC231	Lasik Flap Irrigating
5.	OC188	Lasik Irrigating Cannula
6.	OI-5006	Sterilization Box

## Microsurgery Femto Lasik Set

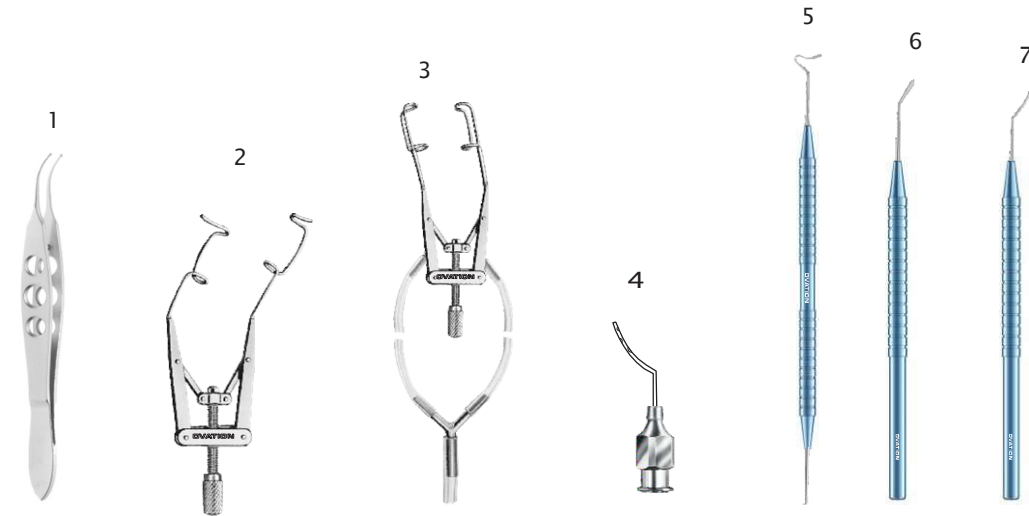

No.	Product Code	Product Name
1.	OI-919	BURRATO LASIK FLAP FORCEPS CURVED
2.	OI-2404	LIEBERMANN-TENNANT EYE SPECULUM FENESTRATED OPEN BLADES
3.	OI-2405	KNORZ LASIK EYE SPECULUM FENESTRATED WITH ASPIRATION
4.	OC 192	LASIK IRRIGATING CANNULA (BURATTO)
5.	OI-2664T	Femto LASIK Flap Spatula, Double Ended
6.	OI-2665T	Femto LASIK Flap Spatula
7.	OI-2666T	Zaldivar Femto LASIK Spatula

## Microsurgery Radial Keratotomy Set

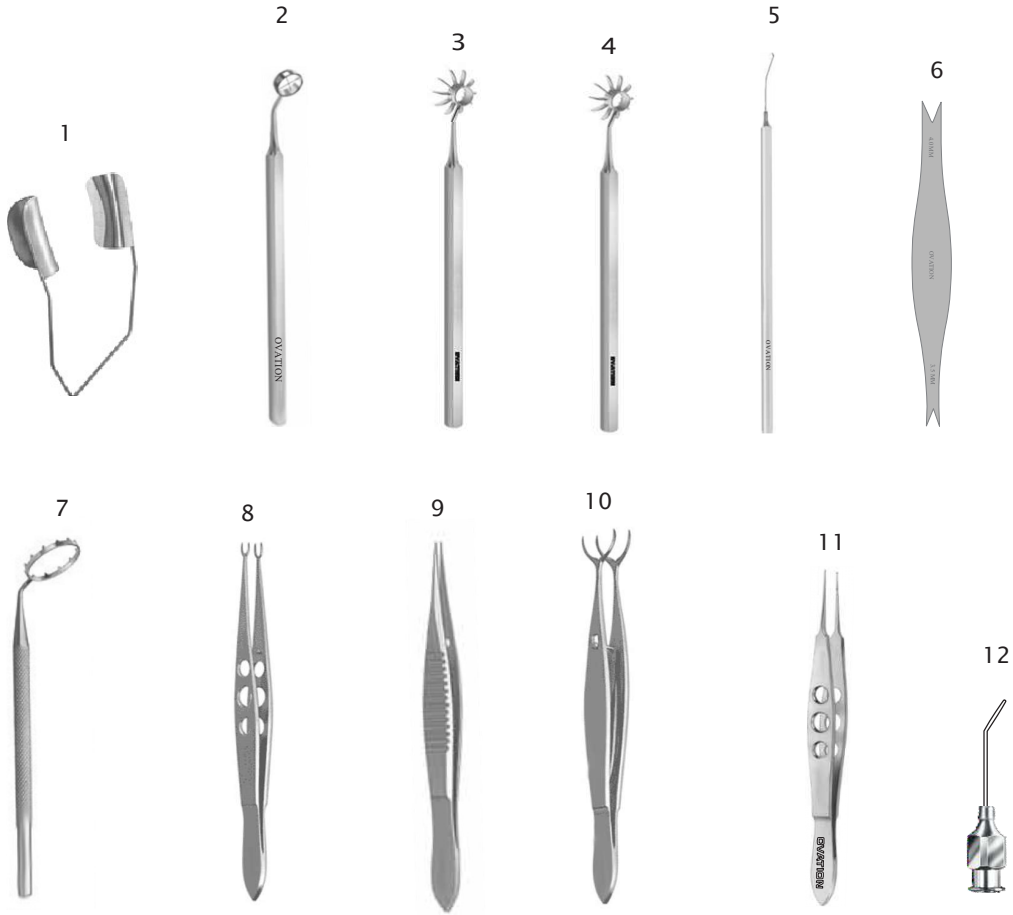

No.	Product Code	Product Name	Qty.
1.	OI-2412	Barraquer Solid Wire Speculum, Large	1
2.	OI-2645	Hoffer Optic Zone Marker (3mm Dia)	1
3.	OI-2635	Osher Neumann Radial Marker (4 Blades)	1
4.	OI-2636	Osher Neumann Radial Marker (6 Blades)	1
5.	OI-2642	Grene Visual Axis Marker 0.5mm Dia Concave Tip	1
6.	OI-3354	Deitz Incision Depth Gauge Size 3.5mm to 4.0mm	1
7.	OI-3501	Thornton Fixation Ring 16mm	1
8.	OI-975	Bores Corneal Fixation Forceps, Straight	1
9.	OI-999	Bores Incision Spreading Forceps	1
10.	OI-976	Kramer Corneal Fixation Forceps	1
11.	OI-916	Castroviejo Suturing Forceps Straight 1 x 2 teeth	1
12.	OC-113	Air Injection Cannula, 27G	1

## Microsurgery Lid Set

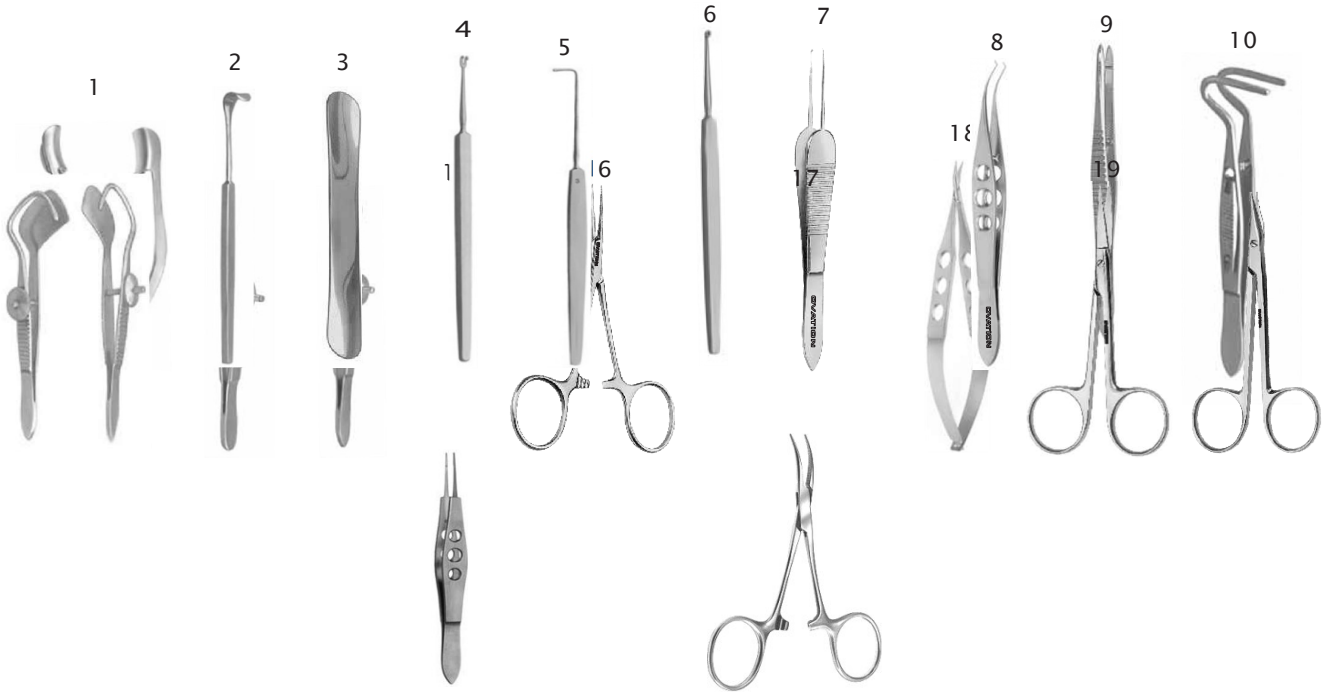

No.	Product Code	Product Name	Qty.
1.	OI-2423	Lancaster Eye Speculum Solid Blade	1
2.	OI-3107	Desmarres Lid Retractor, Size 0	1
3.	OI-3118	Jaeger Lid Plate	1
4.	OI-3461	Fixation Hook, 2.0 x 1.5mm	1
5.	OI-3454	Graefe Muscle Hook, 12mm Size 3	1
6.	OI-3653	Meyerhoefer Chalazion Curette, Size 2	1
7.	OI-917	St. Martin Suturing Forceps, 1 x 2 Teeth	1
8.	OI-966	Fixation Forceps, 1 x 2 Teeth	1
9.	OI-978	Beer Cilia Forceps	1
10.	OI-993	Berke Ptosis Forceps, 20mm	1
11.	OI-991	Snelle Entropium Forceps, Left Small	1
12.	OI-992	Snelle Entropium Forceps, Right Small	1
13.	OI-990	Ayer Chalazion Forceps	1
14.	OI-988	Lambert Chalazion Forceps Round 8mm	1
15.	OI-902	Mc Pherson Tying Forceps, Long Handle	1
16.	OI-2308	Hartman Mosquito Forceps, Straight	1
17.	OI-2337	Hartman Mosquito Forceps, Curved	2
18.	OI-815	Westcott Stitch Scissors	1
19.	OI-818	Eye Scissors, Curved, 4 1/2" Length	1
20.	OI-822	Stevens Tenotomy Scissors, Curved	1

## Microsurgery Lid Set

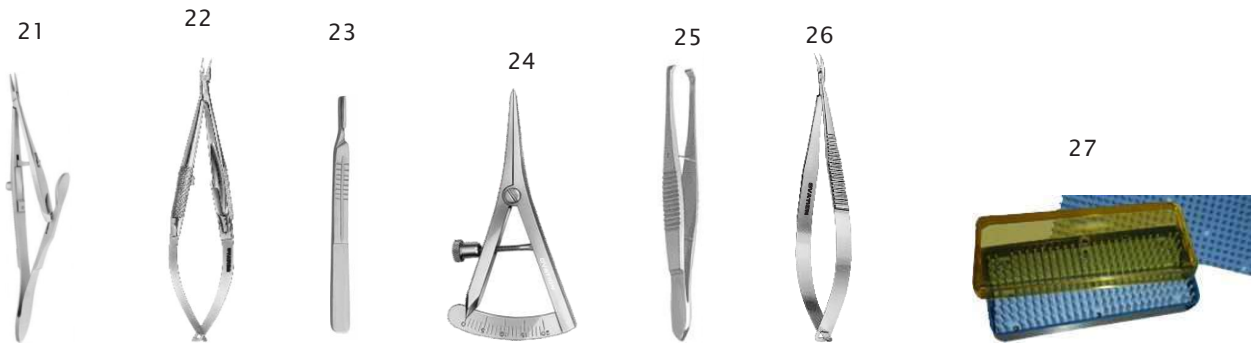

No.	Product Code	Product Name	Qty.
21.	OI-2313	Kalt Needle Holder	1
22.	OI-2301	Barraquer N. Holder, Short Model, M.Jaws, w/o Lock	1
23.	OI-2318	Blade Handle Flat	1
24.	OI-3351	Castroviejo Claiper, Straight Spread 20mm	1
25.	OI-968	Fixation Forceps, 2 x 3 Teeth, Angle	1
26.	OI-801	Universal Corneal Scissors Fine Curved	1
27.	OI-5008	Polycarbonate Sterilisation Tray Large Separate	1

## Microsurgery Enucleation Set

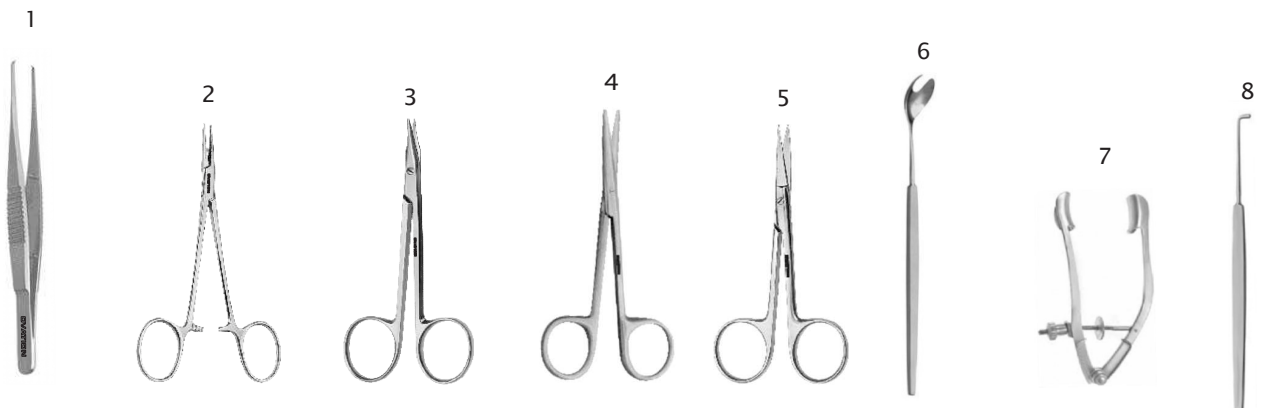

No.	Product Code	Product Name	Qty.
1.	OI-967	Elsching Fixation Forceps	1
2.	OI-2307	Halstead Mosquito Forceps, Straight	2
3.	OI-822	Stevens Tenotomy Scissors, Curved	1
4.	OI-823	Enucleation Scissors, Straight	1
5.	OI-818	Eye Scissors, Straight	1
6.	OI-3665	Wells Enucleation Spoon	1
7.	OI-2423	Lancaster Eye Speculum	1
8.	OI-3452	Graefe Muscle Hook Size 1	1

## Microsurgery Chalazion Set

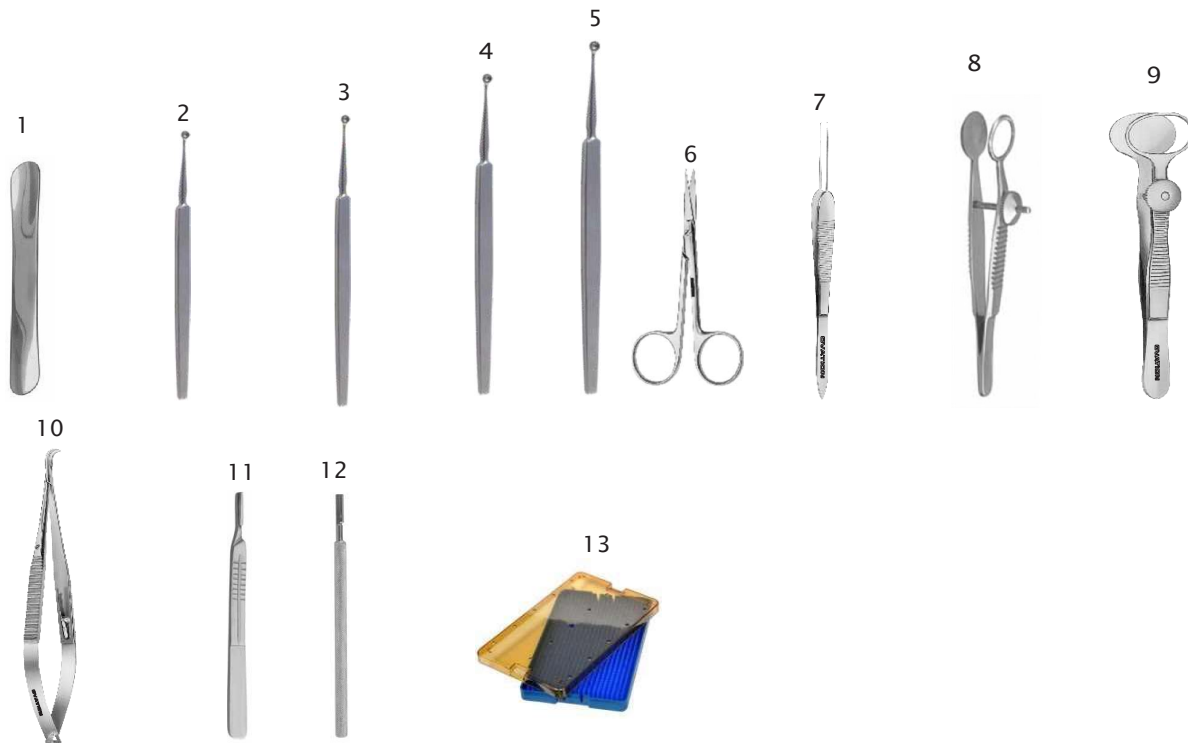

No.	Product Code	Product Name	Qty.
1.	OI-3118	Jaeger Lid Plate	1
2.	OI-3651	Meyerhoefer Chalazion Curette, Size 0, 1.50mm dia	1
3.	OI-3652	Meyerhoefer Chalazion Curette, Size 1, 1.75mm dia	1
4.	OI-3653	Meyerhoefer Chalazion Curette, Size 2, 2.25mm dia	1
5.	OI-3654	Meyerhoefer Chalazion Curette, Size 3, 3.00mm dia	1
6.	OI-819	Eye Scissors, Curved, 4.5" Length	1
7.	OI-917	St. Martin Suturing Forceps, 1c x 2 Teeth	1
8.	OI-989	Hunt Chalazion Forceps, 12mm dia	1
9.	OI-928	Desmarres Chalazion Forceps, 13mm / 20mm dia	1
10.	OI-2303	Castroviejo Needle Holder, Curved Without Lock	1
11.	OI-2318	Blade Handle Flat	1
12.	OI-2335	Blade Handle Round	1
13.	OI-5008	Polycarbonate Sterilization Tray Large	1

## Microsurgery Muscle Set

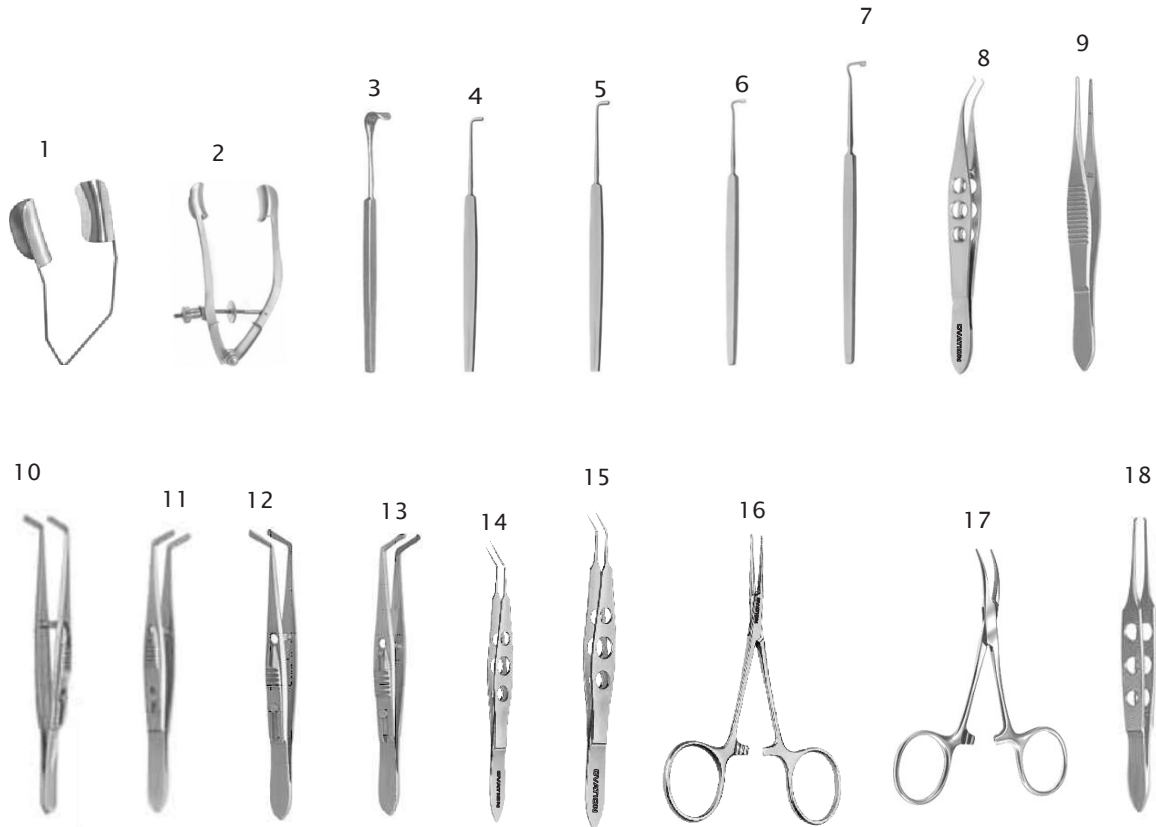

No.	Product Code	Product Name	Qty.
1.	OI-2412	Barraquer Wire Speculum, Large	1
2.	OI-2423	Lancaster Eye Speculum Solid Blade	1
3.	OI-3107	Desmarres Lid Retractor, Size 0	1
4.	OI-3452	Graefe Muscle Hook Size 1	1
5.	OI-3453	Graefe Muscle Hook Size 2	1
6.	OI-3455	Jameson Muscle Hook, Small	1
7.	OI-3456	Jameson Muscle Hook, Large	1
8.	OI-966	Fixation Forceps, 1 x 2 Teeth	1
9.	OI-979	Wills Hospital Utility Forceps	1
10.	OI-994	Jameson Muscle Forceps, Left, Child 4 Teeth	1
11.	OI-995	Jameson Muscle Forceps, Right, Child 4 Teeth	1
12.	OI-1002	Worth Advancement Forceps, Left	1
13.	OI-1003	Worth Advancement Forceps, Right	1
14.	OI-904	Mc Pherson Tying Forceps, Long Handle	1
15.	OI-903	Kelman - McPherson Forceps, Long Handle 7.5mm Angled	1
16.	OI-2308	Hartman Mosquito Forceps, Straight	1
17.	OI-2337	Hartman Mosquito Forceps, Curved	1
18.	OI-965	Bishop Harmon Forceps	1

## Microsurgery Muscle Set

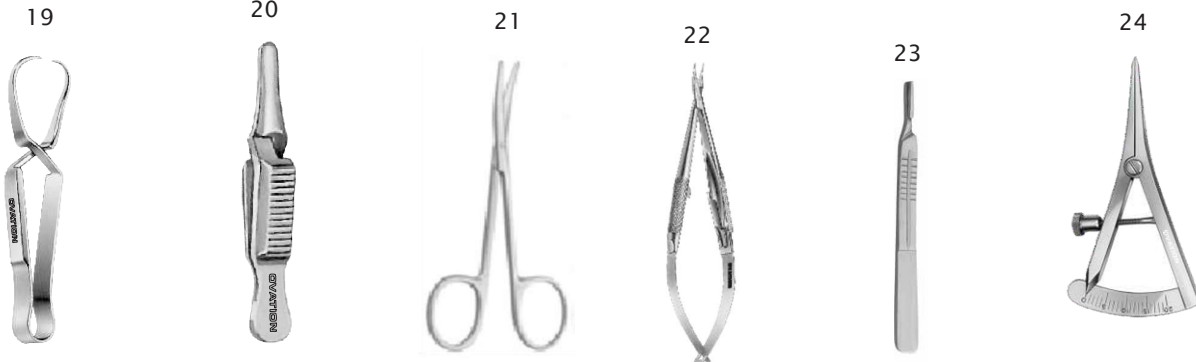

No.	Product Code	Product Name	Qty.
19.	OI-2310	Baby Jones Towel Clamp	1
20.	OI-822	Stevens Tenotomy Scissors, Curved	1
21.	OI-824	Enucleation Scissor Ring Handle , Curved	1
22.	OI-2301	Barraquer N.Holder, Short Model, M.Jaws, Curved, w/o Lock	1
23.	OI-2318	Blade Handle Flat	1
24.	OI-3351	Castroviejo Caliper Straight	1

## Microsurgery Retinal Set

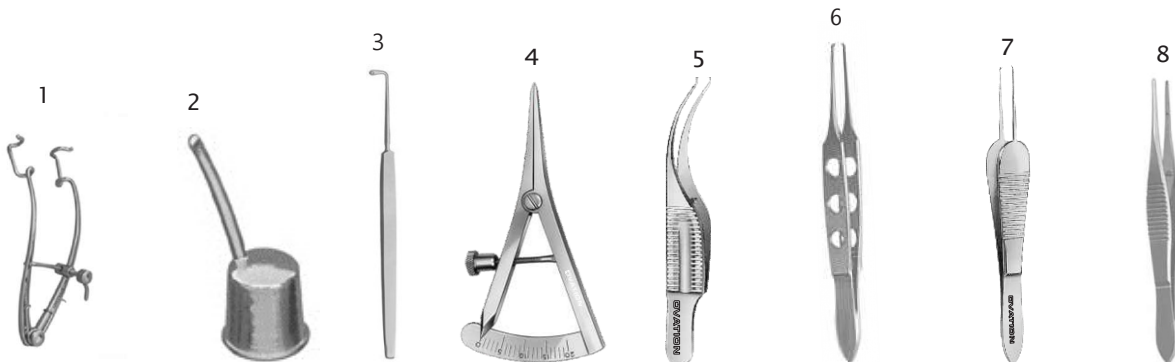

No.	Product Code	Product Name	Qty.
1.	OI-2419	Clark Eye Speculum, Small	1
2.	OI-3251	Schepens Scleral Depressor, Small # 8	1
3.	OI-3457	Gass Retinal Detachment Hook	1
4.	OI-3351	Castroviejo Caliper, Straight	1
5.	OI-910	Colibri Forceps, 1 x 2 Teeth, 0.12mm	1
6.	OI-965	Bishop-Harmon Tissue Forceps, Delicate 0.8mm	1
7.	OI-917	St. Martin Suturing Forceps, 1 x 2 Teeth	1
8.	OI-979	Wills Hospital Utility Forceps	1

## Microsurgery Retinal Set

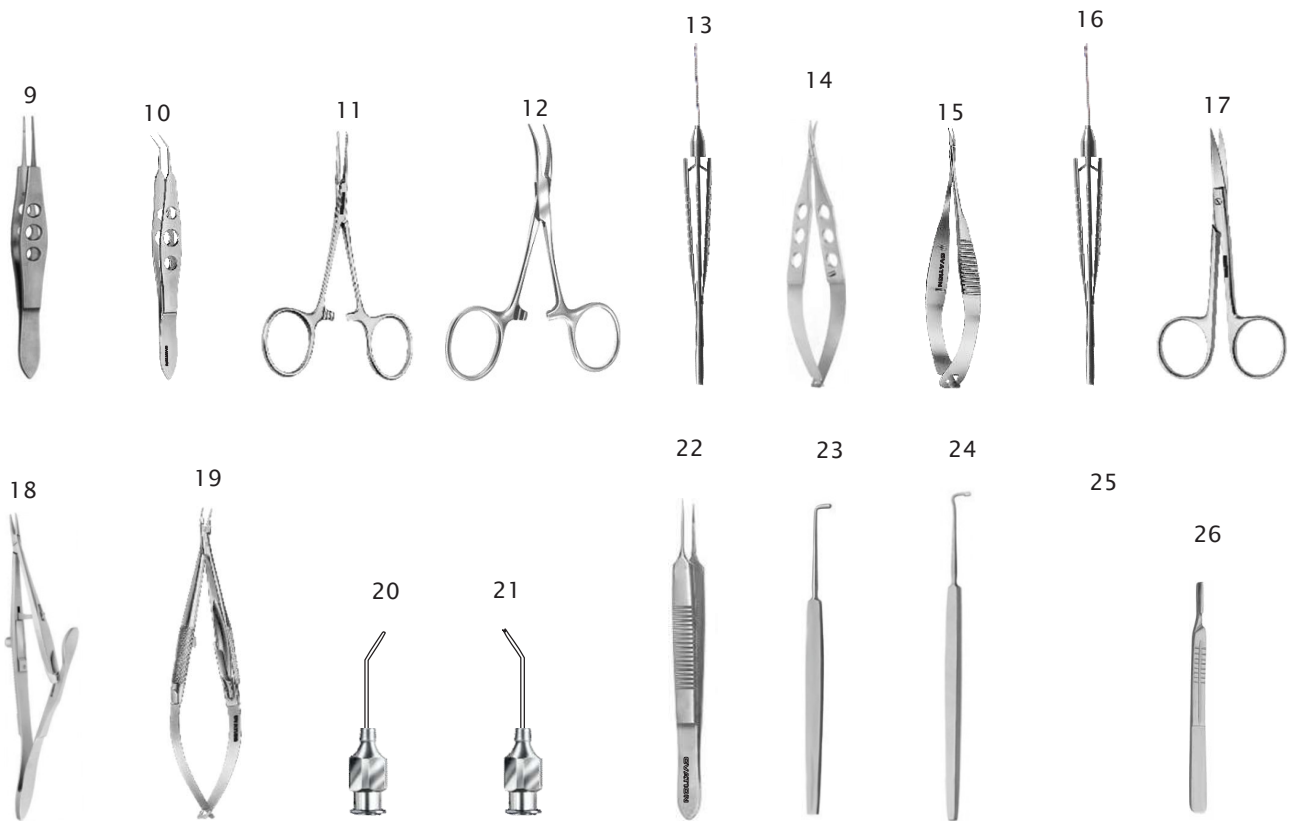

No.	Product Code	Product Name	Qty.
9.	OI-902	Mc Pherson Tying Forceps, Long Handle	1
10.	OI-903	Mc Pherson Forceps, 11mm Angles	1
11.	OI-2308	Hartman Mosquito Forceps, Straight	1
12.	OI-2337	Hartman Mosquito Forceps, Curved	1
13.	OI-2256	Vitreous Forceps, 20G Smooth Jaws, Straight	1
14.	OI-815	Westcott Stitch Scissors	1
15.	OI-806	Vannas Capsulotomy Scissors, Curved	1
16.	OI-2256	Vitreous Scissors, 20G Straight	1
17.	OI-819	Eye Scissors, Curved 4 1/2" Length	1
18.	OI-2313	Kalt Needle Holder, Straight	1
19.	OI-2319	Barraquer N. Holder, Short Model, M. Jaws, Curved W/o Lock	1
20.	OC-113	Rycroft Air Injection Cannula, 27G	1
21.	OC119	Bishop Harmon Anterior Chamber Cannula, 19G	1
22.	OI-914	Mc Pherson Corneal Forceps	1
23.	OI-3452	Graefe Muscle Hook	1
24.	OI-3455	Jameson Muscle Hook Small	1
25.	OI-3115	Schepens Forked Orbital Retractor	1
26.	OI-2318	Blade Handle Flat	1

## Foreign Body Removal Set

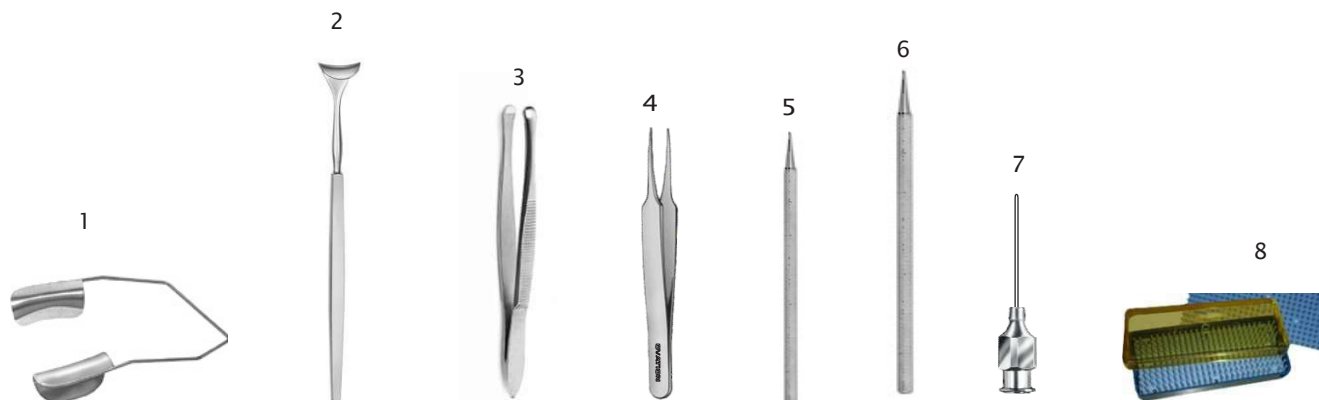

No.	Product Code	Product Name	Qty.
1.	OI-2412	Barraquer Wire Speculum, Big	1
2.	OI-3109	Desmarres Lid Retractor, Size 2	1
3.	OI-978	Beer Cilia Forceps	1
4.	OI-927	Jewellers Forceps, Standard	1
5.	OI-3556	Wilder Lacrimal Dilator Size 1 FinemTaper	1
6.	OI-3557	Wilder Lacrimal Dilator Size 2 Medium Taper	1
7.	OC-117	Irrigating Cannula Straight Blunt Tip 21G x22mm Length	1
8.	OI-5006	Sterilization Box 2.5 x 6.0 x 0.75 (Inch)	1

## Microsurgery Pterygium Set

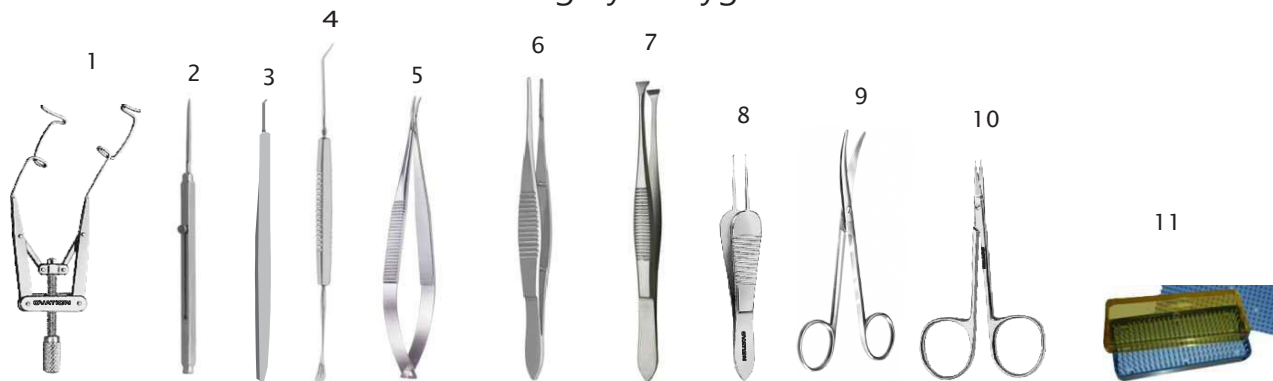

No.	Product Code	Product Name	Qty.
1.	OI-2404	Liebermann-Tennant Eye speculum, Open Blades	1
2.	OI-3306	Barraquer Cataract Knife	1
3.	OI-3308	Paufigue Graft Knife	1
4.	OI-3207	Paton Spatula	1
5.	OI-2303	Castroviejo N. Holder, Delicate Jaws, Cur. W/o Lock	1
6.	OI-1004	Bonaccolto Utility Forceps	1
7.	OI-969	Fixation Forceps,	1
8.	OI-917	St. Martin Suturing Forceps	1
9.	OI-824	Enucleation Scissor Ring Handle medium curve	1
10.	OI-816	Iris Scissors, Straight	1
11.	OI-5007	Polycarbonate Sterilisation Tray Medium (4.0 x 7.5 x 0.75)"	1

## Microsurgery Cataract Set (Complete)

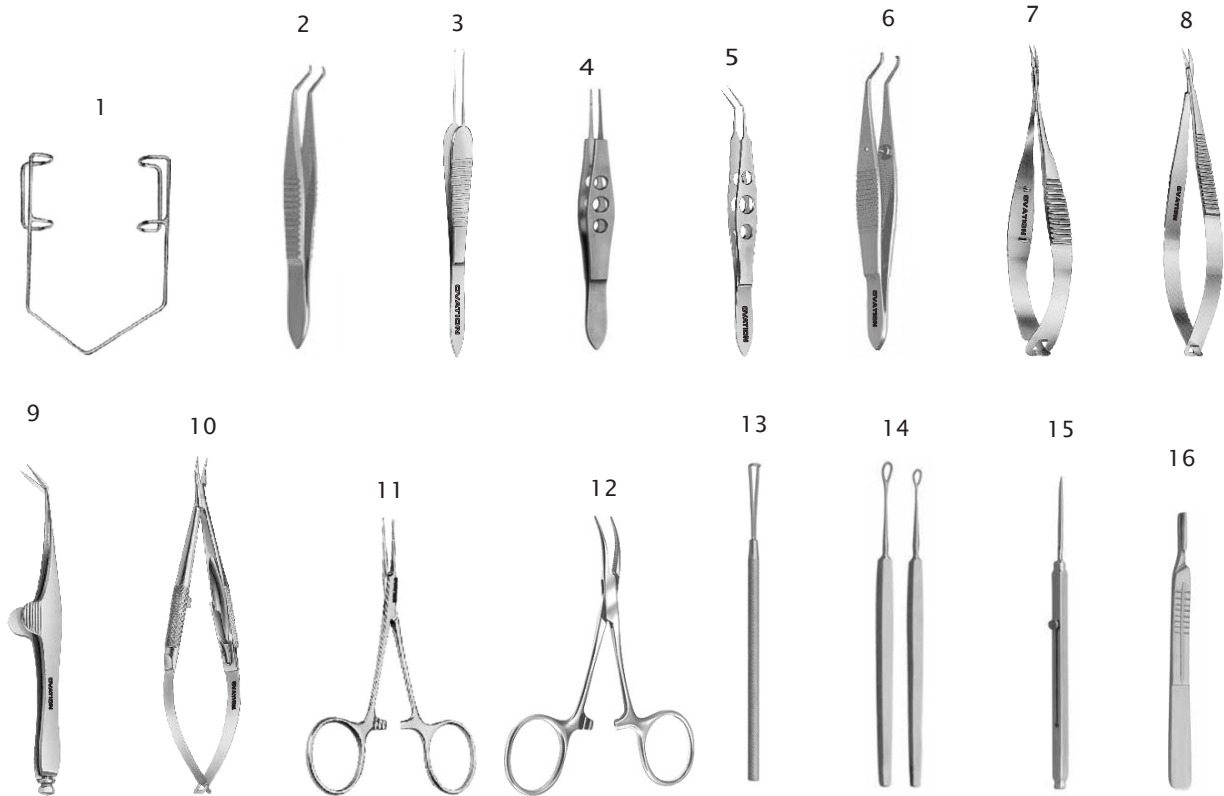

No.	Product Code	Product Name	Qty.
1.	OI-2401	Barraquer Wire Speculum	1
2.	OI-974	Hess Iris Forceps	1
3.	OI-917	St. Martin Forceps	1
4.	OI-902	Jaffe Tying Forceps (Straight)	1
5.	OI-904	Mc Pherson Forceps, Angled 11mm	1
6.	OI-964	Superior Rectus Forceps	1
7.	OI-806	Cannas Capsulotomy Scissors, Curved	1
8.	OI-801	Castroviejo Corneal Scissors, Universal	1
9.	OI-813	De - Wecker's Iris Scissors	1
10.	OI-2301	Barraquer Needle Holder, Micro	1
11.	OI-2308	Hartman Mosquito Forceps, Straight	1
12.	OI-2337	Hartman Mosquito Forceps, Curved	1
13.	OI-3111	Dastoor Iris Retractor, Straight	1
14.	OI-3152	Lewis Lens Loop, Small	1
15.	OI-3306	Barraquer Cataract Knife, Sliding	1
16.	OI-2318	Blade Handle Flat	1

## Microsurgery Squint/Strabismus Set

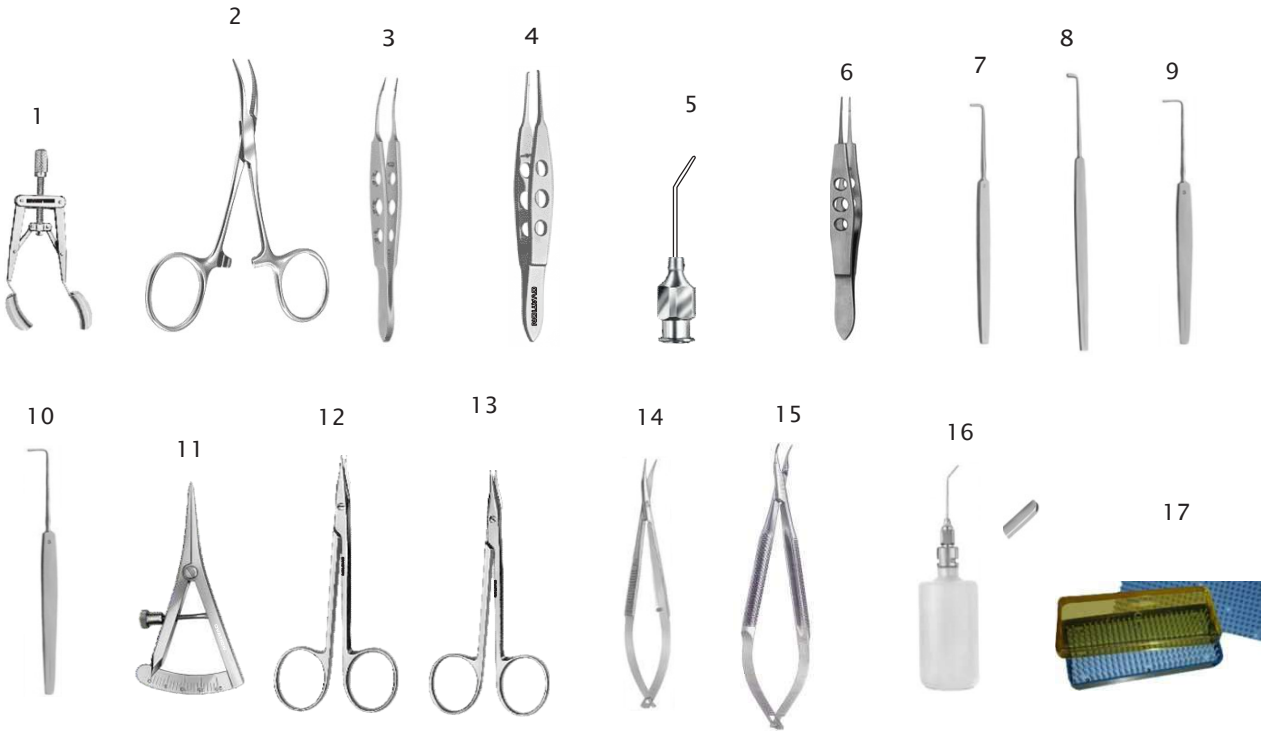

No.	Product Code	Product Name	Qty.
1.	OI-2403	Kershner Eye Speculum Solid Blades	1
2.	OI-2337	Hartmann Mosquito Forceps Curved	2
3.	OI-971	Moody Fixation Forceps 1 X 2 Teeth 5mm	1
4.	OI-915	Bonn Forceps Straight, 1 x 2 teeth at 90° 0.12mm	1
5.	OC-113	Rycroft Air Injection Cannula, 19G	2
6.	OI-901	Jaffe Tying Forceps smooth jaws Curved	1
7.	OI-3453	Graefe Muscle Hook 10mm	1
8.	OI-3454	Graefe Muscle Hook 12mm	1
9.	OI-3455	Jamson Muscle hook Small	1
10.	OI-3456	Jamson Muscle hook Big	1
11.	OI-3351	Castroviejo Caliper, Straight	1
12.	OI-821	Stevens Tenotomy Scissors Straight Ring handle	1
13.	OI-822	Stevens Tenotomy Scissors Curved Ring handle	1
14.	OI-814	Wescott Tenotomy Scissor Curved Blunt Tips	1
15.	OI-2301	Barraquer Needle Holder 10mm Handle Curved	1
16.	OI-3851	Silicon Bulb with Adaptor	1
17.	OI-5009	Sterilizing Case, 6.0 x 10 x 0.75Inch	1

## DLEK / DSAEK / DALK Set

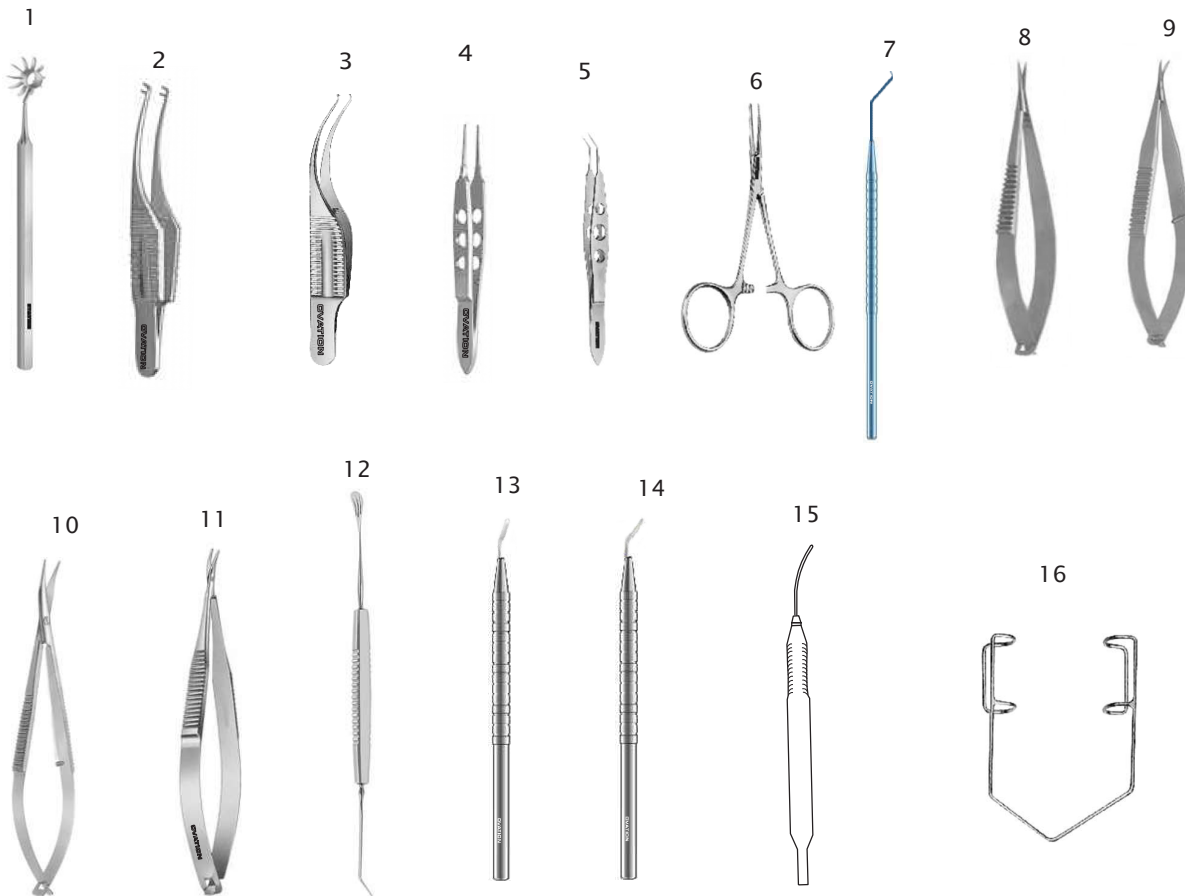

No.	Product Code	Product Name	Qty.
1.	OI-2635	Osher-Neumann Radial Marker	1
2.	OI-958	Polack Corneal Transplant Fixation Forceps Titanium	1
3.	OI-910	Castroviejo Colibri Corneal Forceps Stainless Steel	1
4.	OI-963	Castroviejo Suturing Forceps 0.12mm	1
5.	OI-906	Kelman McPherson Angled Tying Forceps Stainless Steel	1
6.	OI-2337	Hartmann Mosquito Forceps, Straight	1
7.	OC-152	Sinskey Hook, Reverse	1
8.	OI-830	Iris Scissors Straight	1
9.	OI-831	Iris Scissors Curved	1
10.	OI-833	Gills Vannas Capsulotomy Scissor Curved	1
11.	OI-815	Westcott Stitch Scissors	1
12.	OI-3207	Paton Spatula	1
13.	OI-2633	LAMELLAR DISSECTOR bevel up sharp round edge	1
14.	OI-2634	LAMELLAR DISSECTOR blunt round tip	1
15.	OC-219	Irrigating Endothelial Stripper	1
16.	OI-2401	Barraquer Wire Speculum	1

## DLEK / DSAEK / D ALK Set



No.	Product Code	Product Name	Qty.
17.	OC-113	Cannula Rycroff	1
18.	OC-115	Anterior Chamber Maintainer	1
19.	OI-3851	Silicone Bulb with Adapter	1
20.	OI-2310	Schaedel 90mm Towel Forcep	1
21.	OI-4005	Maloney Astigmatic Keratometer	1
22.	OI-3401	Corneal Trephine Blades 7.5 mm and 8.0 mm	3
23.	OI-3403	Corneal Trephine Universal Handle	1
24.	OI-5011	Plastic sterilizing tray with silicone mat Double	1

## Coaxial Microphaco Set

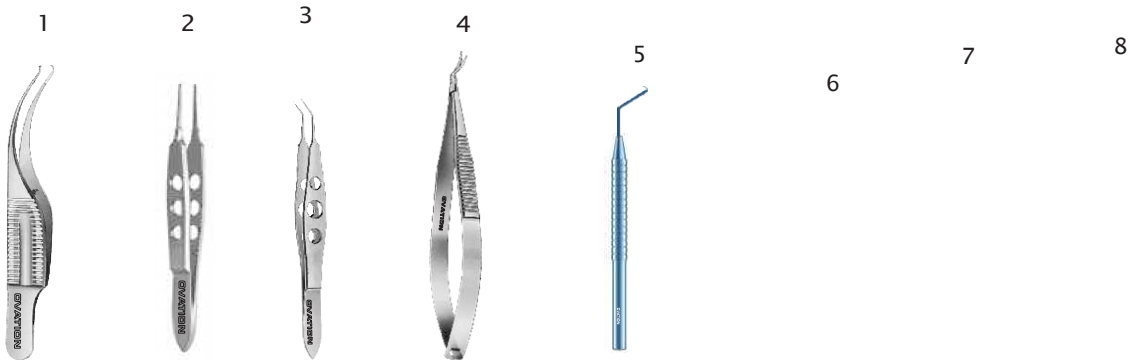

No.	Product Code	Product Name	Qty.
1.	OI-910	Colibri Corneal Forceps	1
2.	OI-916	Castroviejo Suturing Forceps 0.12mm	1
3.	OI-903	McPherson Angled Tying Forceps	1
4.	OI-803	Corneal Scissor Castroviejo Right Blunt Tips	1
5.	OC-152	Sinskey hook	1
6.	OVF6145	45 degree side port knife 0.6mm	1
7.	OVR621820	Ovation Knife 1.8 to 2.0mm	1
8.	OVR621824	Ovation Knife 2.0 to 2.4mm	1

## Coaxial Microphaco Set

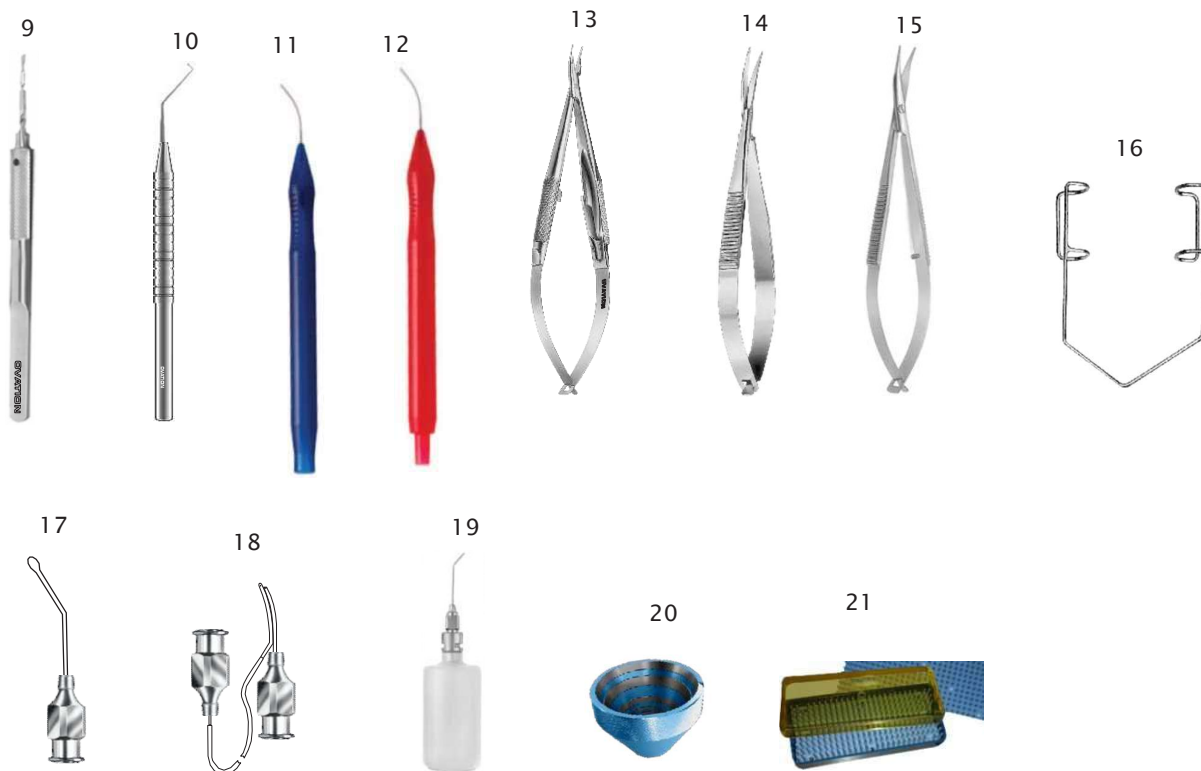

No.	Product Code	Product Name	Qty.
9.	OI-984	Akahoshi Combo Prechopper for 2.0mm Incision	1
10.	OI-3852	Nucleus Sustainer with ring end tip	1
11.	OC221	Bimanual Irrigation Handpiece	1
12.	OC216	Bimanual Aspiration Handpiece, Polisher Tip	1
13.	OI-2301	Barraquer Needle Holder Extra Fine Curved	1
14.	OI-814	Westcott Stitch Scissor	1
15.	OI-833	Gills-Vannas Capsulotomy Scissor Angled	1
16.	OI-2401	Barraquer Wire Speculum	1
17.	OC-118	Olive Tip Cannula Curved	1
18.	OC-122	I / A Cannula Simcoe	1
19.	OI-3851	Silicone Bulb with adapter	1
20.	OI-4005	Maloney Astigmatic Keratometer	1
21.	OI-5011	Plastic sterilizing tray with silicone mat Double	1

## MICROSURGERY Keratoplasty Set

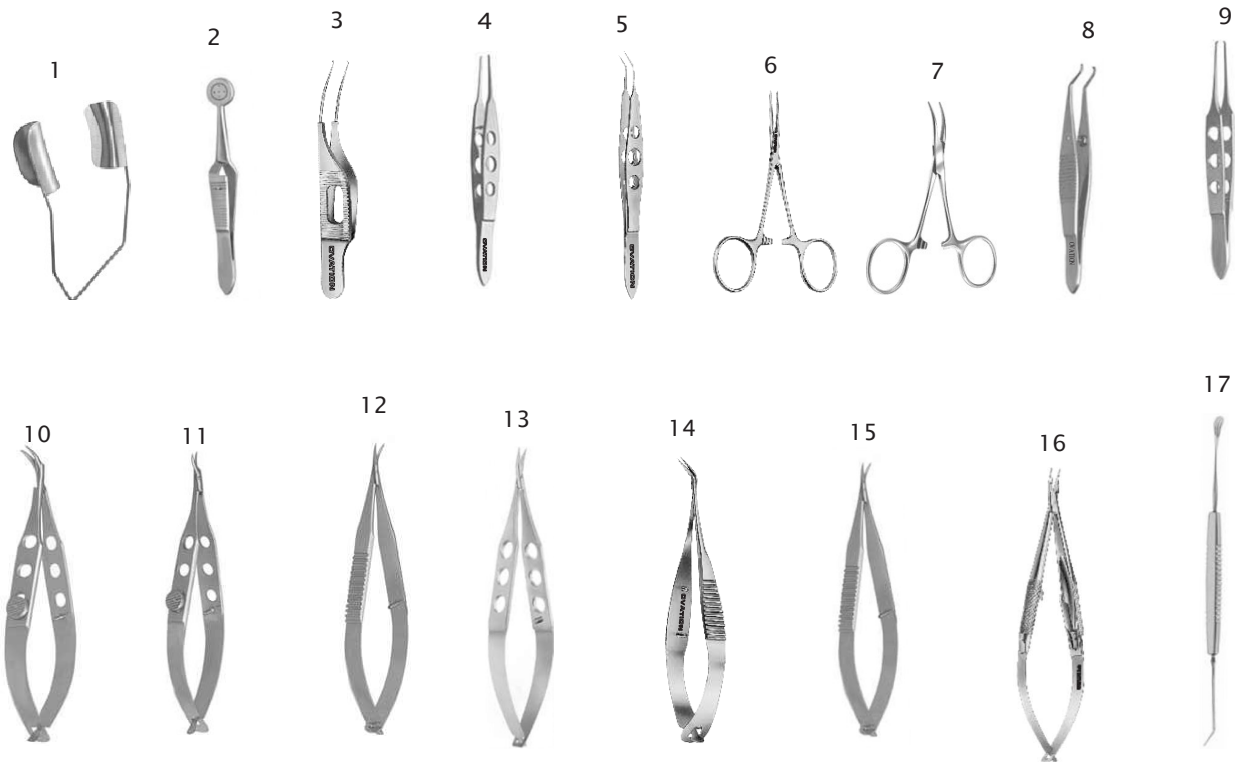

No.	Product Code	Product Name	Qty.
1.	OI-2412	Barraquer Solid Wire Speculum, Large	1
2.	OI-1000	Corneal Graft Holding Forceps	1
3.	OI-911	Micro Colibri Cornealsceral Forceps with tying Platform 0.12mm	1
4.	OI-915	Bonn Forceps, 1 x 2 Teeth Set at 90°, 0.12mm, Long Model	1
5.	OI-903	Kelman Mc Pherson Forceps, Long Handle, 7.5mm Angled	1
6.	OI-2308	Hartman Mosquito Forceps, Straight	1
7.	OI-2337	Hartman Mosquito Forceps, Curved	1
8.	OI-964	Superior Rectus Forceps	1
9.	OI-965	Bishop Harmon Tissue Forceps, Delicate, 0.8mm	1
10.	OI-826	Corneal Transplant Scissors (Trought-Katzin) LEFT	1
11.	OI-827	Corneal Transplant Scissors (Trought-Katzin) RIGHT	1
12.	OI-831	Micor IRIS Scissor Curved	1
13.	OI-815	Westcott Stitch Scissors	1
14.	OI-808	Vannas Capsulotomy Scissors, Ang. Forward, 11mm Blade	1
15.	OI-831	Iris Scissors, Straight, 3 1/2" Length	1
16.	OI-2301	Barraquer N. Holder, Short Model, M.Jaws, Cur. w/o lock	1
17.	OI-3207	Paton Spatula and Spoon	1

## MICROSURGERY Keratoplasty Set

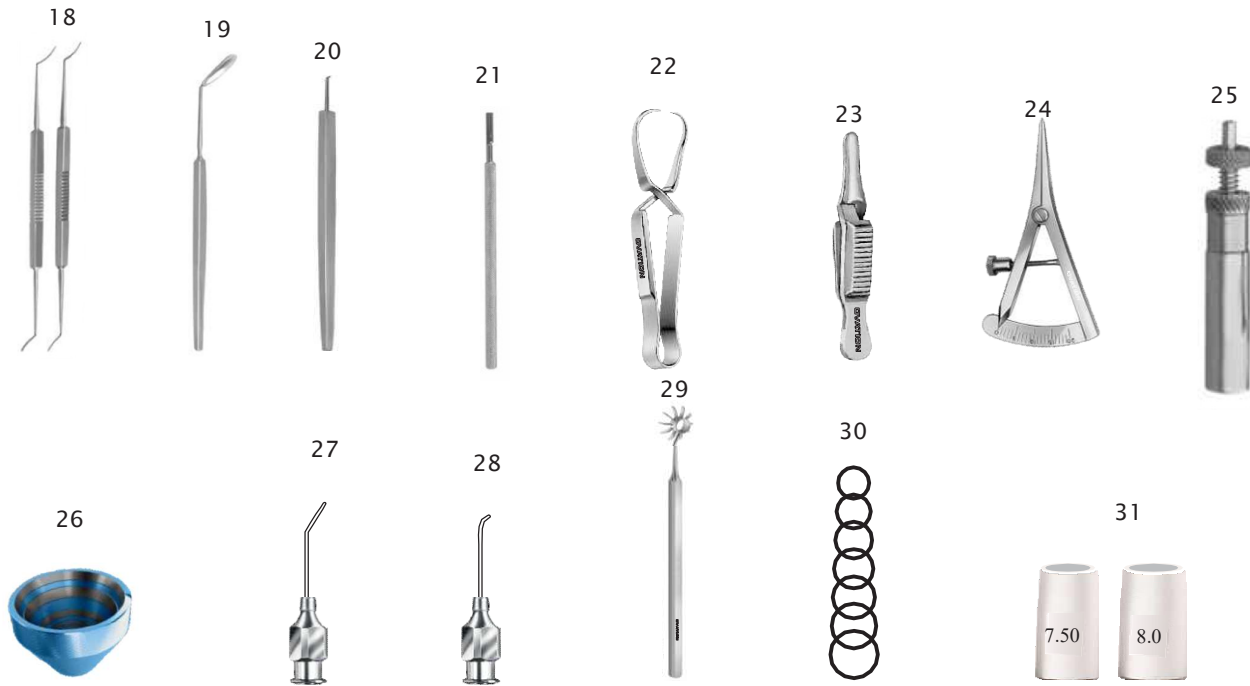

No.	Product Code	Product Name	Qty.
18.	OI-3204	Castroviejo Cyclodialysis Spatula	1
19.	OI-3206	Keratoplasty Spatula	1
20.	OI-3308	Paufigue Graft Knife	1
21.	OI-2335	BLADE HANDLE ROUND	1
22.	OI2310	Schaedel Towel Forceps 90mm	1
23.	OI-2311	Serrefine Small, Straight	1
24.	OI-3351	Castroviejo Caliper, Straight	1
25.	OI-3407	Vaccume Suction Trephine	1
26.	OI-4005	Maloney Intraoperative Keratometer	1
27.	OC-113	Rycroft Air Injection Cannula, 27G Reusable	1
28.	OC-114	Bracken Anterior Chamber Cannula, Curved and Straight, 19G	1
29.	OI-2637	Osher - Neumann Radial Marker, 8 Blades	1
30.	OI-3504	Flieringa Scleral Fixation Ring (Set of 8 Sizes)	1
31.	OI-3401	Disposable Trephine, Size 7.0, 7.5, 7.25, 7.75, 8.0,	1

### Optional



No.	Product Code	Product Name	Qty.
32.	OI-3405	ENDOTHELIAL PUNCH	1
33.	OI-3851	Silicon Bulb with adapter	1
34.	OI-5009	Tray Polycarbonate with single Mat 152 x 254 x 19mm	1

## Microsurgery Vitreo Retinal Set 23G

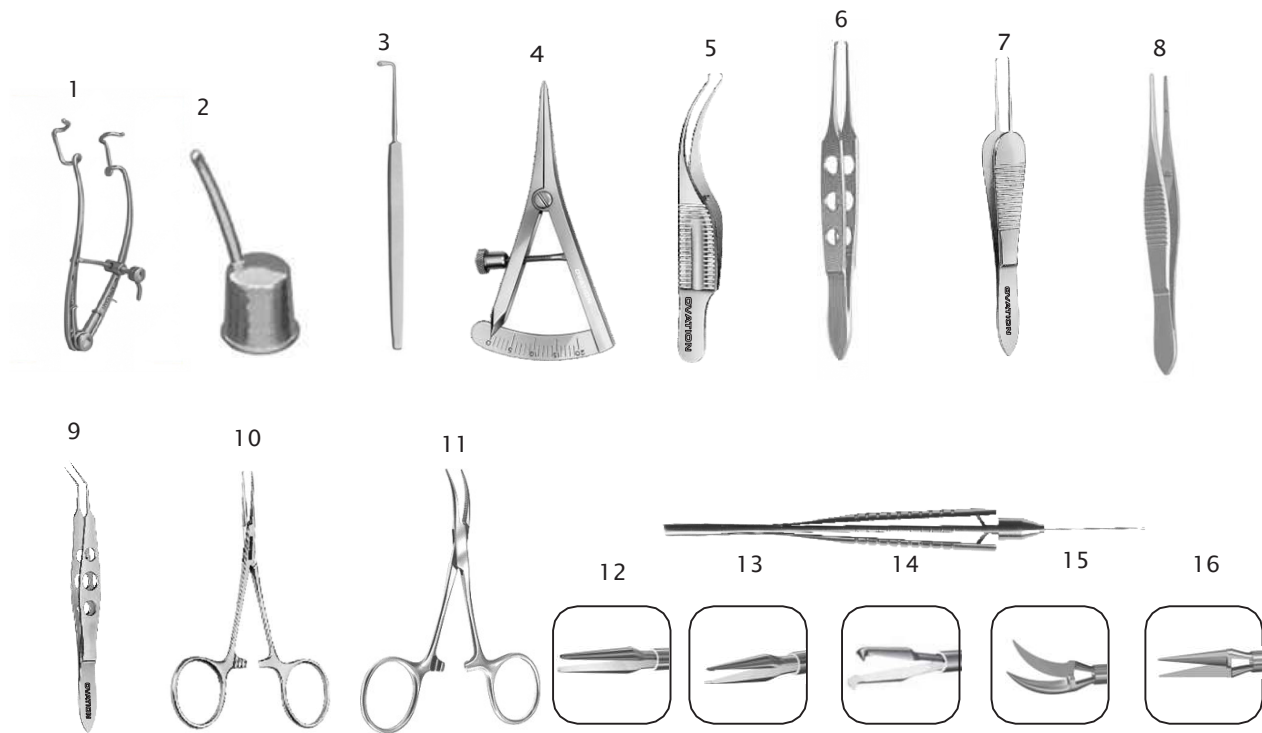

No.	Product Code	Product Name	Qty.
1.	OI-2419	Clark Eye Speculum, Small	1
2.	OI-3251	Schepens Scleral Depressor, Small # 8	1
3.	OI-3457	Gass Retinal Detachment Hook	1
4.	OI-3351	Castroviejo Caliper, Straight	1
5.	OI-910	Colibri Forceps, 1 x 2 Teeth, 0.12mm	1
6.	OI-965	Bishop - Harmon Tissue Forceps, Delicate 0.8mm	1
7.	OI-917	St. Martin Suturing Forceps, 1 x 2 Teeth	1
8.	OI-979	Wills Hospital Utility Forceps	1
9.	OI-904	Mc Pherson Forceps, 11mm Angles	1
10.	OI-2308	Hartman Mosquito Forceps, Straight	1
11.	OI-2337	Hartman Mosquito Forceps, Curved	1
12.	OI-2201-23G	Viterous Forceps, Staright Tip 23G	1
13.	OI-2204-23G	Viterous Forceps, Endgrip Tip 23G	1
14.	OI-2218-23G	Viterous Forceps, "PICK" 23G	1
15.	OI-2253-23G	Vitreous Scissors, 23G Curved	1
16.	OI-2257-23G	Vitreous Scissors, 23G Blunt tips	1

## Microsurgery Vitreo Retinal Set 23G

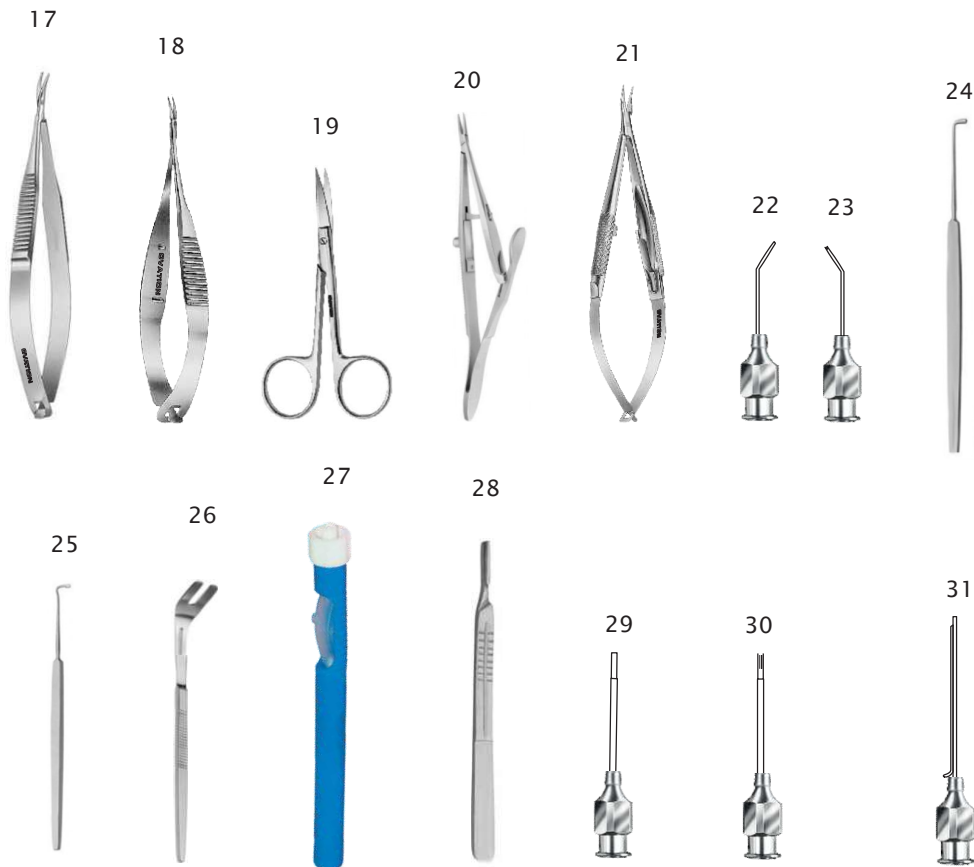

No.	Product Code	Product Name	Qty.
17.	OI-815	Westcott Stitch Scissors	1
18.	OI-806	Vannas Capsulotomy Scissors, Curved	1
19.	OI-819	Eye Scissors, Curved 4 1/2" Length	1
20.	OI-2313	Kalt Needle Holder, Straight	1
21.	OI-2301	Barraquer Needle Holder	1
22.	OC-113	Rycroft Air Injection Cannula, 27G	1
23.	OC-119	Bishop - Harmon Anterior Chamber Cannula, 19G	1
24.	OI-3452	Graefe Muscle Hook 1	1
25.	OI-3455	Jameson Muscle Hook Small	1
26.	OI-3115	Schepens Forked Orbital Retractor	1
27.	OI-2318	Bard Parker Handle # 3	1
28.	OC-141	Back Flush Flute handle Lure Lock	1
29.	OC-138	Silicone Tip Cannula 23G	1
30.	OC-139	Silicone Brush Cannula 23G	1
31.	OC-177	PFCL Cannula 23G	1
32.	OV-6010D	Polycarbonet Sterilisation Tray large	1

## Microsurgery Probing Set (Syrringing)

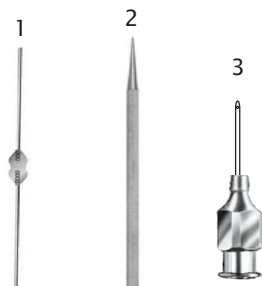

No.	Product Code	Product Name	Qty.
1.	OI-3555	Bowman Lacrimal Probe, Malleable S.S.(Set)	1
2.	OI-3557	Lacrimal Dialator set of 3	1
3.	OC-197	Lacrimal Cannula, 26G	1
4.	OI-3851	CurvedSilicone Bulb With Adaptor	1

## Ocuplastic Instruments Set



No.	Product Code	Product Name	Qty.
1.	OI-2423	Lancaster eye speculum solid blade	1
2.	OI-3114	Schepens orbital retractor	1
3.	OI-3109	Desmarres lid retractor size 2 13mm	1
4.	OI-3118	Jaeger lid plate	1
5.	OI-3105	Knapp lacrimal sac retractor 4 prong sharp	1
6.	OI-3654	Meyerhoefer chalazion curette size 3	1
7.	OI-3662	Bunge evisceration spoon large	1
8.	OI-3453	Graefe muscle hook #2 10mm	1
9.	OI-821	Stevens tenotomy scissor blunt tip ringh handle straight	1
10.	OI-824	Enucleation scissor ring handle medium cure	1
11.	OI-965	Bishop harom tissue forceps	1

Pioneer in Ophthalmic Products

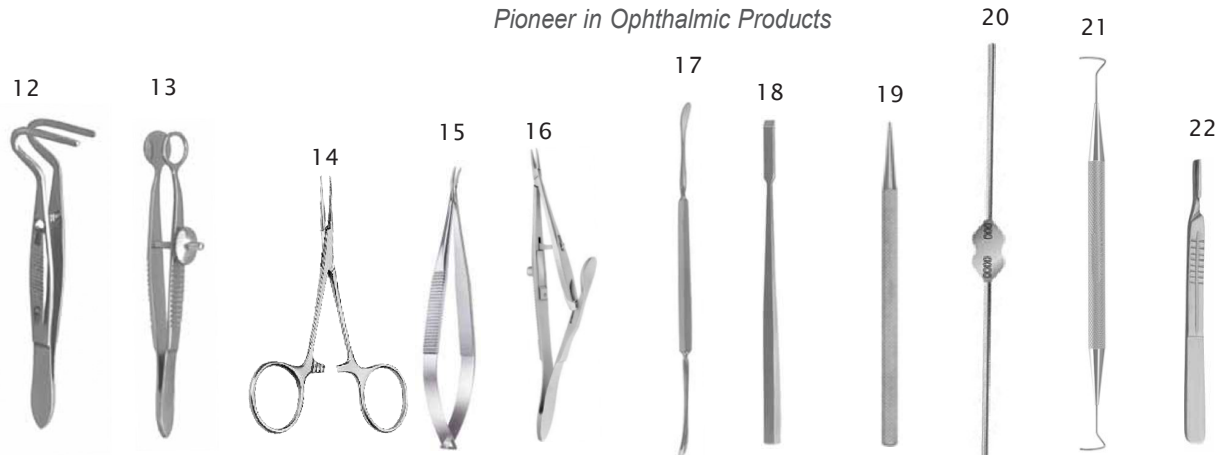

No.	Product Code	Product Name	Qty.
12.	OI-993	Berke ptosis forceps	1
13.	OI-988	Lambert chalazion forceps round, 8 mm	1
14.	OI-2308	Hartmann mosquito forceps straight	1
15.	OI-2303	Castroviejo needle holder curved, without lock	1
16.	OI-2313	Kalt needle holder st	1
17.	OI-3560	Freer periosteal elevator	1
18.	OI-3551	West lacrimal chisel straight	1
19.	OI-3557	Wilder lacrimal dilator size 2 medium taper	1
20.	OI-3555	Bowman lacrimal probe malleable stainless steel set of 5	1
21.	OI-3562	Pigtail probe with suture hole double ended	1
22.	OI2318	Bard-parker handle flat handle	1
23.	OV6010D	Polycarbonate sterilisation tray large ( 6.0 x 10 x 0.75) inch	1
			1
			1

## TRICHIASIS SET



No.	Product Code	Product Name	Qty.
1.	OI-2318	Bard Parker Blade	1
2.	OI-2307	Halstead Haemostatic Forceps, Straight 5 , Lock	1
3.	OI-970	Lester Conjunctival Forceps Straight 1x2	1
4.	OI-816	Iris Scissors (4 cm)	1
5.	OI-2303	Castroviejo Needle Holder, Extra Delicate Jaws, without Lock	1
6.	OI-3131	TRABUT PLATE FORCEPS	1
7.	OI-5013	Gallipot (Lotion Bowl)	1
8.	OI-5004	Kidney Dish	1

8



*Pioneer in Ophthalmic Products*

## CARE AND CLEANING OF VITREORETINAL INSTRUMENTS

All Ovation vitreoretinal instruments have a precision delicate mechanism inside with a very thin shaft with inner diameter ranging from 0.7 mm to 0.35 mm depending on shaft gauge. Intraocular fluids may enter this mechanism during surgery. If these fluids are not promptly and properly cleaned out, it will lead to the possibility of instrument malfunction, because salt, debris, protein and viscoelastic can be accumulated inside the mechanism. Moreover, after the sterilization cycle, debris, proteins and viscoelastic can be backed inside the instrument and stop the mechanism from functioning properly.

1. Unscrew the tip from the handle, then attach flushing adapter
2. Ultrasonically clean both parts, if possible.
3. Flush the tip two or three times with distilled or deionized water by connecting syringe filled with water to adapter.
4. Flush the tip with alcohol. This will remove the water and facilitate drying.
5. Dry the tip by forcing one or two syringes full of air through tip. Air under pressure is recommended, as it flushes out debris and fluid more efficiently than syringe forced air. Thoroughly dry handle, tip and adapter.
6. Force special heat resistant instrument milk through the tip, following instruction in No 3 above.
7. Dry with air following instruction in No 5 above.
8. Handle should be soaked in distilled or deionized water for two minutes.
9. Dry with surgical sponge.
10. Lubricate joints in handle with special heat resistant instrument milk.
11. Sterilize the instruments using ETO.

## CARE AND CLEANING OF MICROSURGICAL INSTRUMENTS

### 1. STORAGE

Surgical instruments should be stored in sterilizing trays of proper size lined with soft silicone mats. Instruments should not touch each other. We recommend using protective tips made of soft silicone tubing of the proper size and thickness. Do not use rubber or plastic protective tips, which can melt during autoclaving and cause damage of instruments.

### 2. INSPECTION

Be sure to inspect every micro surgical instrument at the end of your surgical day. Please conduct this inspection under a microscope or with a magnification lens. If a damaged instrument is detected, send it in for repair or replace it.

### 3. CLEANING

#### MANUAL CLEANING

Use mild soap solution approved for surgical instruments with a soft brush or instrument wipe, clean instrument and removes any stains. Never use abrasive powders or steel wool to remove stubborn stains \_ these can damage the super fine finish of an instrument and can actually help cause corrosion of stainless instruments. Use distilled or dematerialized water to rinse instruments thoroughly, then carefully dry them with a hot air blower or lint free cloth.

#### ULTRASONIC CLEANING

This is the best method of cleaning surgical instruments. Use only cleaning solutions approved for surgical instruments. Change the solution frequently, always use dematerialized or distilled water. Heat water to 150°Fahrenheit (62°C) using an immersion heater, or in a separate stainless container, if your unit does not have an automatic built-in water heater. Be sure that you and members of your staff are completely familiar with the manufacturer's instructions, which came with your ultrasound cleaner. Instruments should not touch each other in the ultrasonic cleaner. After removing instrument(s) from the ultrasonic cleaner, rinse the instruments under running water first, and then rinse again in clean dematerialized or distilled water. Dry with a lint free cloth or hot air blower

### 4. LUBRICATION

Normally micro surgical instruments do not require lubricating baths. However, it is recommended to lubricate all moving parts after each cleaning. Use only silicone or Teflon lubricants which can hold up under autoclaving. We recommend the use of Instrument Milk. Never use ordinary lubricants or cover up even the slightest corrosion with a lubricant.

### 5. STERILIZATION

Ovation instruments are reusable unless marked otherwise. All reusable instruments meet ANSI/AAMI standards for sterilization. Sterilization must always be performed in accordance with your institution's standards. Stainless steel and titanium instruments can be sterilized via steam autoclaving, chemical disinfectants, ethylene oxide gas, or even dry hot air. Follow the sterilizer manufacturer's instructions for operation and loading autoclave. For standard sterilization, steam autoclaving is recommended at the standard cycle of 270°F (130°C) for 5 minutes. Other times and steam temperature cycles may also be used. Consult manufacturers of the autoclave to confirm appropriate cycle times and temperature. Autoclave temperatures should not exceed 280°F (137°C) or damage to nonmetallic instrument parts may occur. Use care when sterilizing your instruments and make sure you and your staff understand the instructions supplied by the manufacturer of your particular sterilizer.



CONTACT INFORMATION

**OVATION** <sup>®</sup> INTERNATIONAL

B-24, (B-1) PRABHU MARG,  
TILAK NAGAR, JAIPUR- 302004 (INDIA)

📞 Tel. : +91 141 2620070, 4020600

✉ E-mail : [info@ovationint.com](mailto:info@ovationint.com)

🌐 web: [www.ovationint.com](http://www.ovationint.com) 

+91-8949765166



*For more information, please contact your local Distributor:*

